

A Assembly Instructions

“Honeycomb Nest” Easy - Swing,

Art. 4591-50- 3

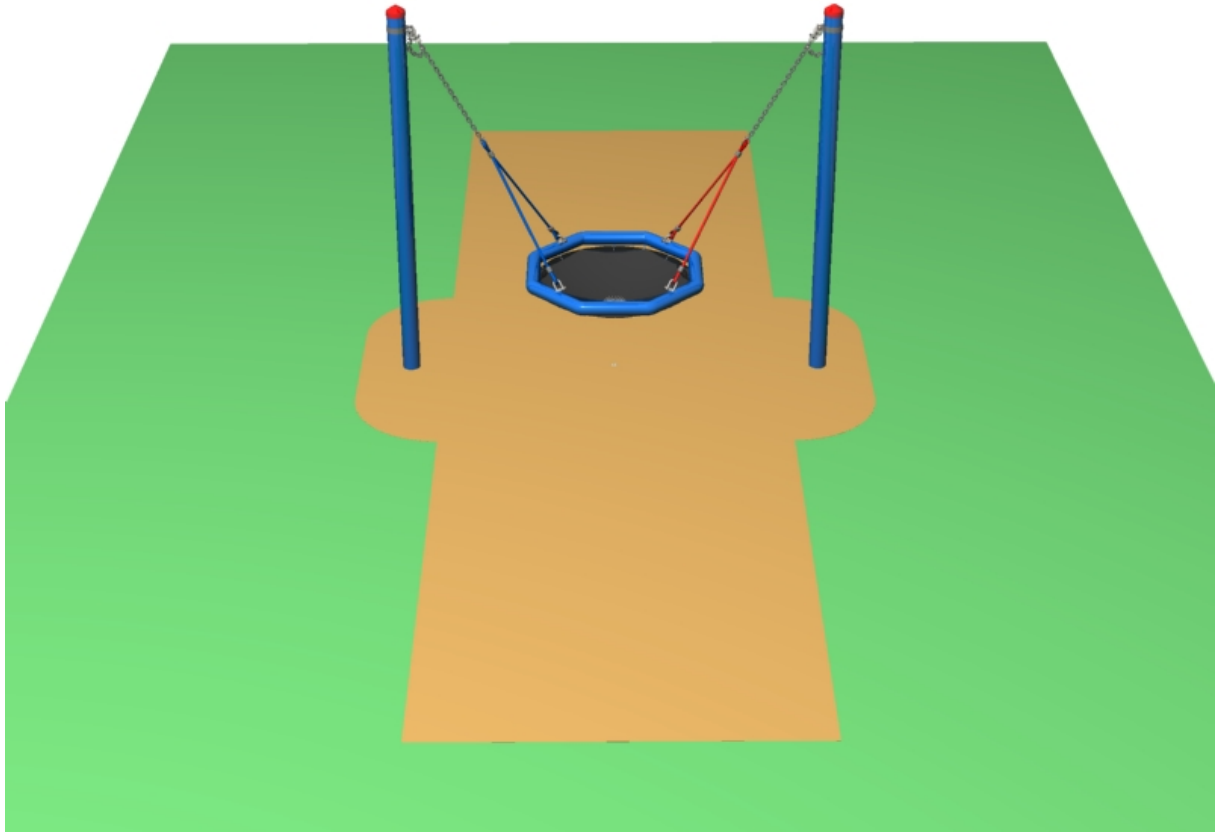

Operator: _____

Location: _____

Contents

| | | |
|----------|--|-----------|
| A | Assembly Instruction | 1 |
| 1 | Introduction installation | 3 |
| 2 | Data sheet..... | 4 |
| 3 | Scope of supply, parts list with part numbers..... | 7 |
| B | Maintenance Instructions | 17 |
| 4 | Introduction maintenance..... | 18 |
| 5 | General maintenance information..... | 19 |
| 6 | Regular maintenance | |
| 7 | Maintenance timetable | 21 |
| 8 | Monthly maintenance | 23 |
| 9 | Quarterly maintenance..... | 23 |
| 10 | Half-yearly maintenance | 23 |
| 11 | Annual main inspection | 24 |
| 12 | Maintenance printout | 27 |
| 13 | Hand-over document..... | 29 |

List of Tables

| | |
|--|---|
| Table 3-1: Scope of supply, parts list with part numbers | 7 |
| Table 3-2: Scope of supply, parts list with part numbers | 8 |

1 Introduction Installation

1.1 General information

This equipment should be installed, inspected, maintained and operated in accordance with EN1176-7 guidelines.

Before installation work commences, please check that you have all of the equipment and fixation components in the parts list provided (see tables 3-1 and 3-2).

Any spare parts that may be required can be obtained directly from your supplier.

Please do not hesitate to call your supplier if you have any problems during installation or in case of any other questions.



Following installation, complete assembly instructions, maintenance instructions and a maintenance record must be sent to the operator who must confirm receipt in writing!! See the last page of this document!!!



All nuts and bolts are hot-dip galvanised or stainless steel. One of the characteristics of stainless steel is that uncontrolled cold welding may occur when the nuts are tightened. To prevent this, it is necessary to spray the nuts and bolts with Teflon spray (for example HTS plus Teflon no. 893128, can be purchased from the company Würth) or another similar lubricant.

2 Data sheet: „Honeycomb Nest“ Easy- Swing, Art. 4591-50-3

1. Space required: 3,00 m x 0,60 m (4591-50-3) resp. 3,00 m x 7,30 m including safety distance (see top view)
Height of fall: 2,00 m

Space required including safety area for part no. 4591-50-3 (please refer to page 10)

Images (individual drawings) are not true to scale!!

2. Specified ground surface:

| Surface material | Description mm | Minimum thickness of layer mm | Maximum height of fall in mm |
|-------------------------------|------------------------------|-------------------------------|------------------------------|
| Lawn/top soil | | | <= 1000 |
| Chipped bark | Grain size 20 – 80 | 400 | <= 3000 |
| Wood chippings | Grain size 5 – 30 | 400 | <= 3000 |
| Sand | Grain size 0,2 – 2 | 400 | <= 3000 |
| Gravel | Grain size 2 – 8 | 400 | <= 3000 |
| Other ground surface material | Like tested according to HIC | | |

*** In Germany, lawn is a sufficient ground surface in the safety zone for heights of up to 1,50 m .**

3. Name and complete dimensions of the largest part of the equipment:
2 steel posts Ø 102 mm - 3,00 m long
4. Allowed age group: 4 years and up
5. **Attention! Unit to be embedded in concrete**
Concrete: C20/25 (B25)
Concrete requirement: ~ 0,4 m³
Size of excavation:
2 x 0,60 m long x 0,60 m wide, total depth 0,90 m including 10 cm percolation layer.
Size of foundation: 2 x 0,60 m long x 0,60 m wide, height 0,60 m



6. **Attention**
Upper edges of concrete are rounded! Foundation sizes apply for regular soil classification 4-5 (grown surface).
Soil classification 4: Light up to medium plasticity, interlaced, with little sediment (proportion < 30 % larger than 63 mm grain size in diameter)
Soil classification 5: Grounds of soil classification 3 and 4 with more sediment (proportion > 30 % larger than 63 mm grain size in diameter)
For safety reasons, foundations of sandy, soft grounds should be layered with a larger surface of at least 50%.
7. Assembly time once steel masts are embedded in concrete:
Approximately 45 minutes. Number of persons required: 2
8. Any spare parts that may be required can be directly obtained by your supplier or Huck Seiltechnik GmbH

Address: Huck Seiltechnik GmbH
Dillerberg 3
D-35614 Asslar/Berghausen
Tel. 06443/8311-0
Fax. 06443/8311-79

We hereby confirm that this play equipment is tested and certified according to the new playing equipment norm EN 1176.

Drawings / views

All optical illustrations simply demonstrate the proportions/dimensions to be followed, but are not binding, technical equipment images.

Technical modifications supporting the advancement of our articles are subject to change.

Tolerances / proportions

Due to the quality and characteristics of equipment parts, minor dimensional tolerances over drawings data are possible.

This regards all visible dimensions, except for foundation dimensions respectively dimensions below OK ground surface/play surface.

9.

3 Scope of supply, parts list with part numbers









3.1 in letters

Table 3-1: Scope of supply, parts list with part numbers

| Pos. | Quantity | Element / description | Size | O.K. | Missing |
|------|----------|--|------------------------|------|---------|
| 1 | 2 | Steel posts | Ø 102 mm - 3,00 m long | | |
| 2 | 2 | Red plastic caps | for Ø 102 mm | | |
| 3 | 2 | Tube clamps (without fixing parts) | | | |
| 4 | 2 | Hexagon screw (for pos. 3 and pos. 7) | M10 x 35 mm lg. | | |
| 5 | 2 | Tube clamps with threaded bolt M10 x 150 mm + 2 nuts | | | |
| 6 | 1 | Play equipment part + safety chain (swing element) | (pre-assembled!) | | |
| | | | | | |
| | | | | | |
| | | | | | |
| | | | | | |
| 100 | 1 | Paint (1 can) + paint brush | | | |
| 101 | 6 | Self-cutting PIAS-screws (for pos. 2) | 5,5 x 25 mm | | |
| 102 | 1 | Loctite (thread locking) | 3 ml | | |
| | | | | | |

3.2 In symbols

Table 3-2: Scope of supply, parts list with part numbers

| Pos. | Quantity | Symbol |
|------|----------|--|
| 1 | 2 |  Ø 102 mm - 3,00 m long |
| 2 | 2 |  for Ø 102 mm |
| 3 | 2 |  |
| 4 | 2 |  M10 x 35 mm lg |
| 5 | 2 |  |
| 6 | 1 |  (pre-assembled!) |
| 100 | 1 |  |
| 101 | 6 |  5,5 x 25 mm |
| 102 | 1 |  Thread locking „Loctite“ 3 ml |

| | <u>Abbreviations and signs</u> |
|---|--|
| AB | Setting time for concrete B25 at least 4 – 5 days |
| AM | Dimension between axes (centre-centre) post |
| LM | Clear post dimension |
| D | Concrete C20/25 (B25) for foundation |
| DR | Top view / outline |
| F | Fall protection |
| FR | Radius of foundation at least 10 cm |
| Gehw. PI. | Support slab e.g. sidewalk slab is to be <u>provided by customer</u> and then placed underneath posts! Upper edge – percolation layer (see drawing) |
| G | Percolation layer 10 cm |
| VA | Front view A |
| O.K. | O.K. play level |
| PS | Space required including safety area |
| WH ! | Hang play element (swing) high enough to guarantee ground clearance of 400 mm from OK play level to lower edge of play equipment part! |
| M.Lot !! | It is mandatory to mount posts perpendicular and horizontal! |
|  | <u>Upper edges of concrete are rounded! Foundation sizes apply for regular soil classification 4-5 (grown surface).</u> <u>Soil classification 4:</u> Light up to medium plasticity, interlaced, with little sediment (proportion < 30 % larger than 63 mm grain size in diameter). <u>Soil classification 5:</u> Grounds of soil classification 3 and 4 with more sediment (proportion > 30 % larger than 63 mm grain size in diameter) <u>For safety reasons, foundations of sandy, soft grounds should be layered with a larger surface of at least 50%.</u> |
| ML | Height of mast above play level |

See drawings

4 Assembly Instruction

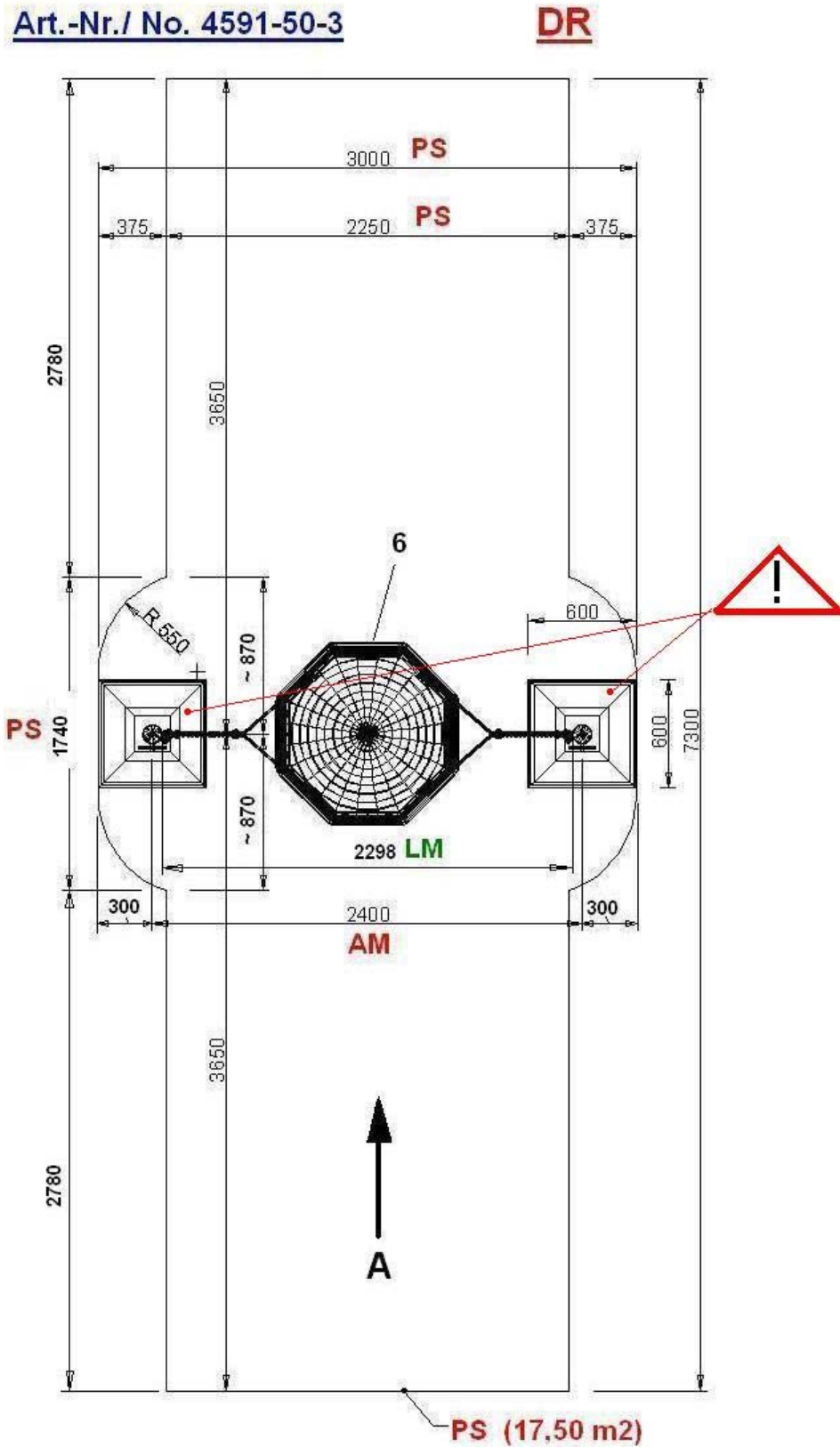

Thread locking !

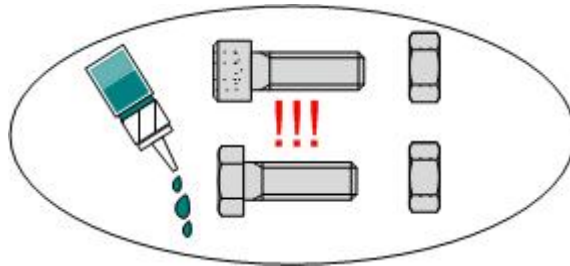

**All screws, nuts and bushes (e.g. Torx-bushes)
must be secured by Loctite!
(stop screw nuts excepted)**

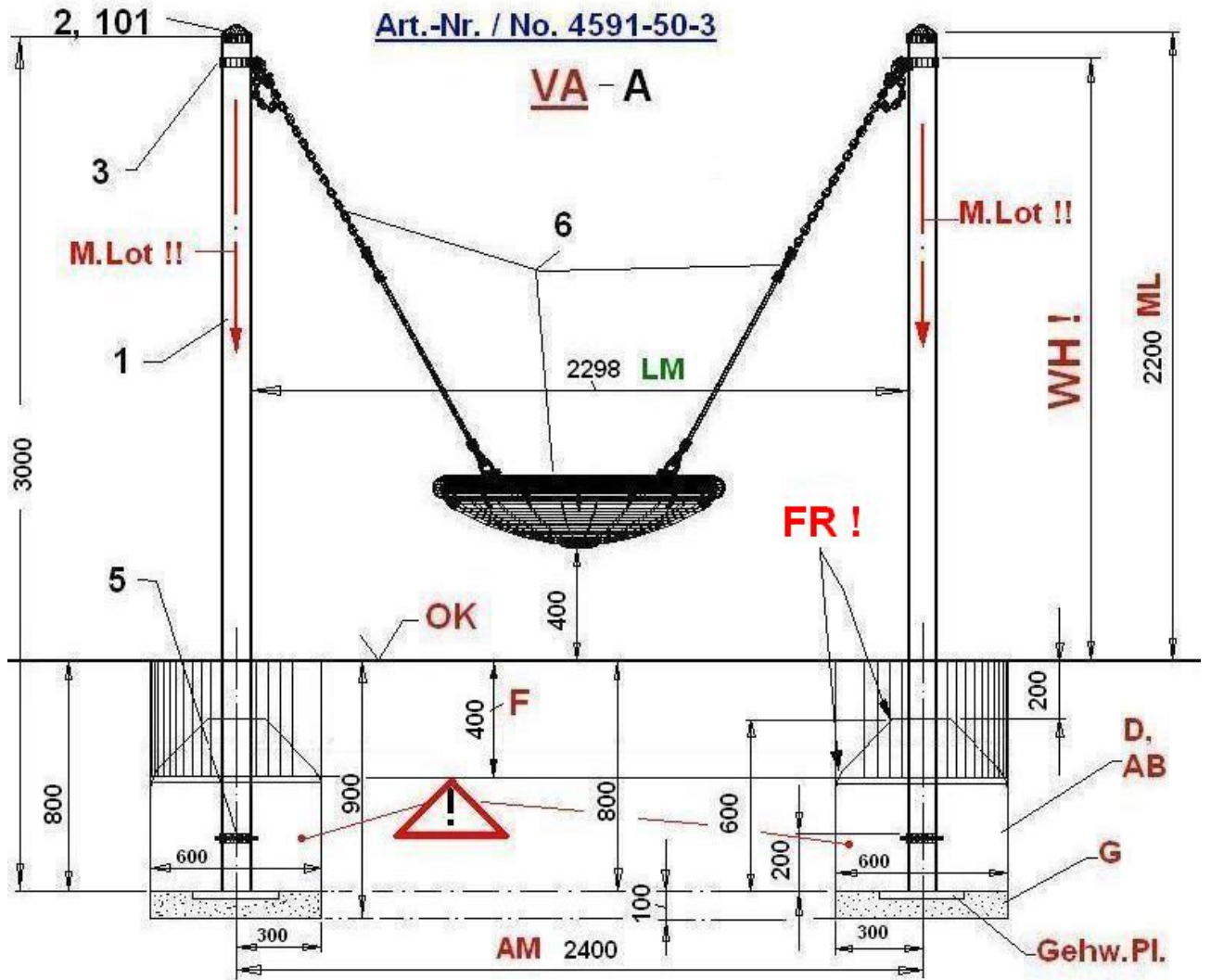

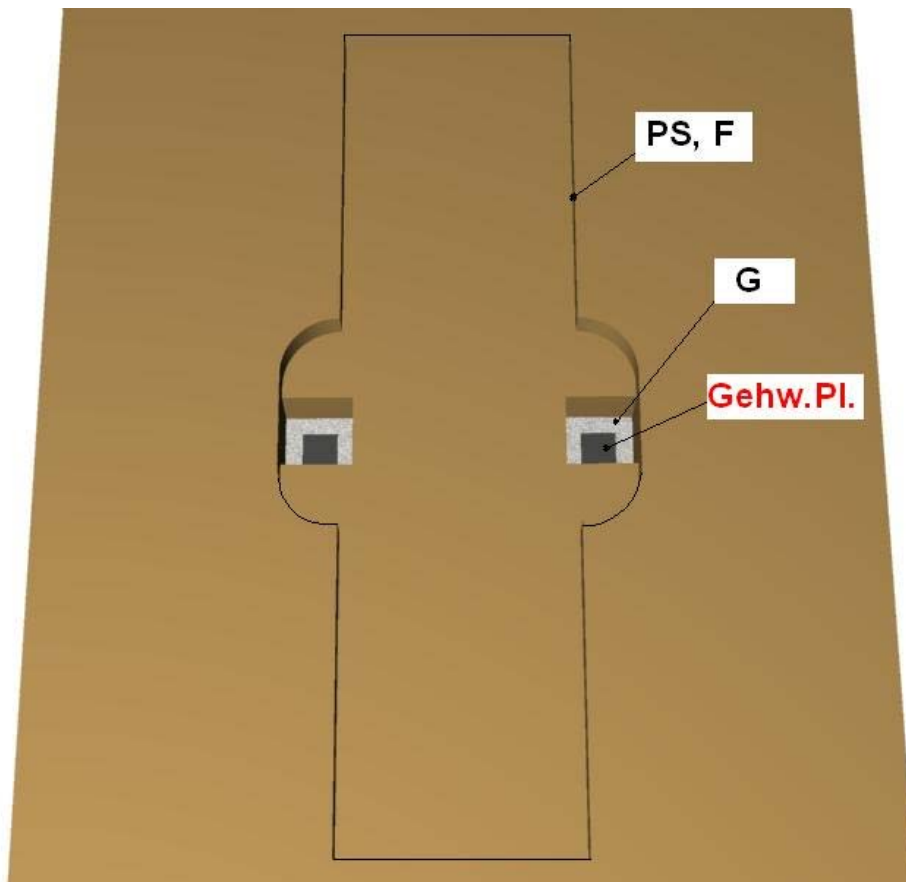
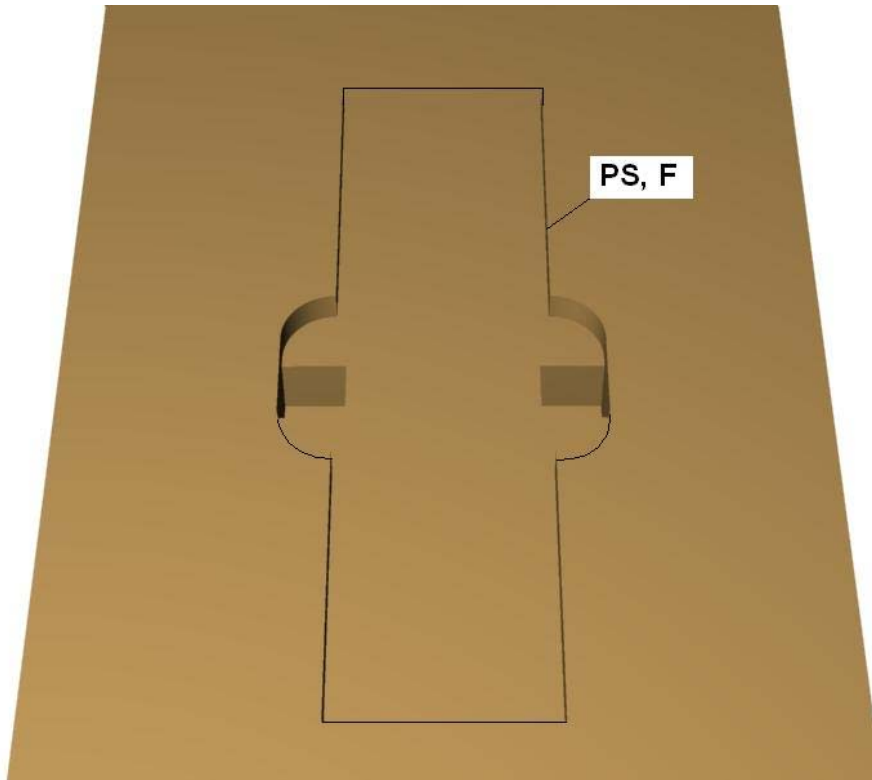

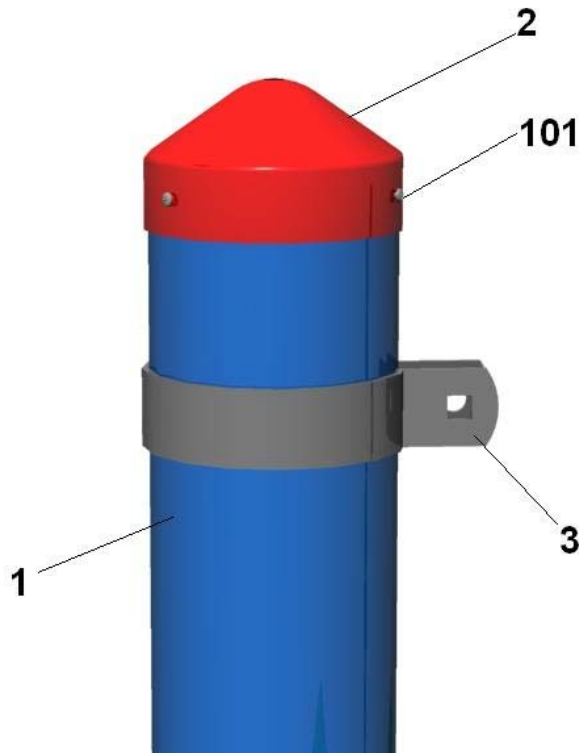
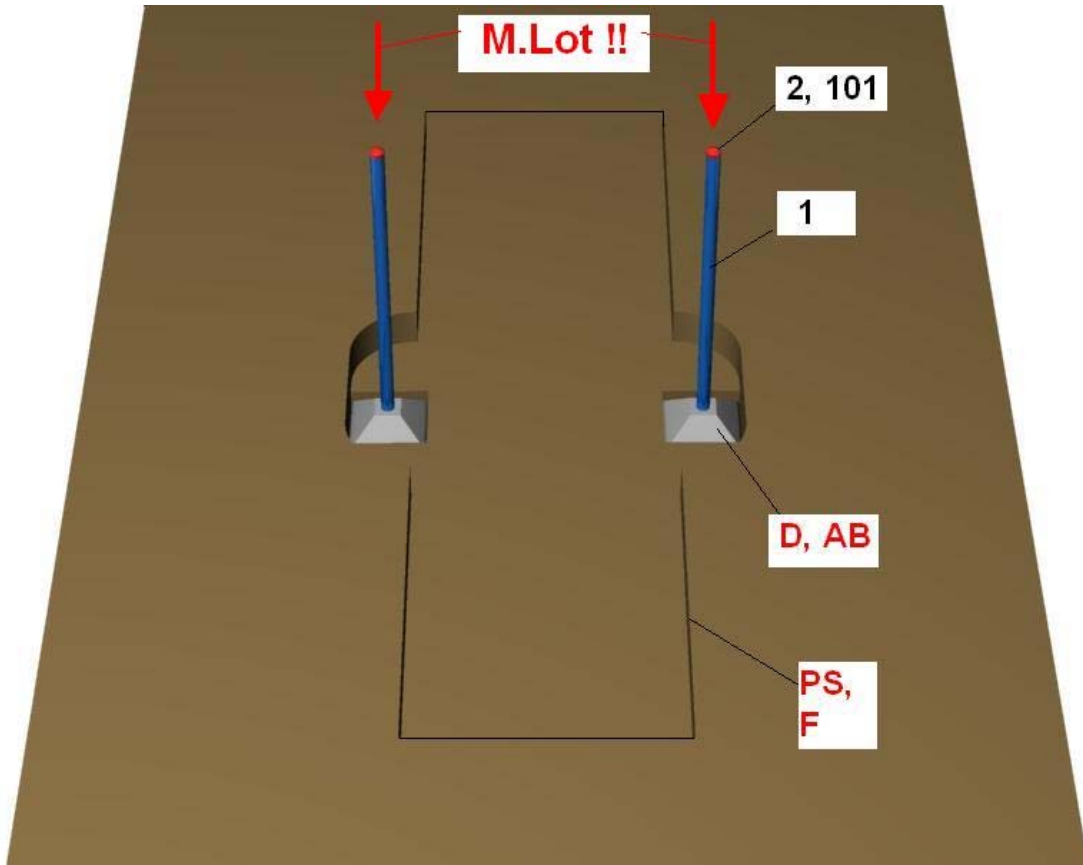

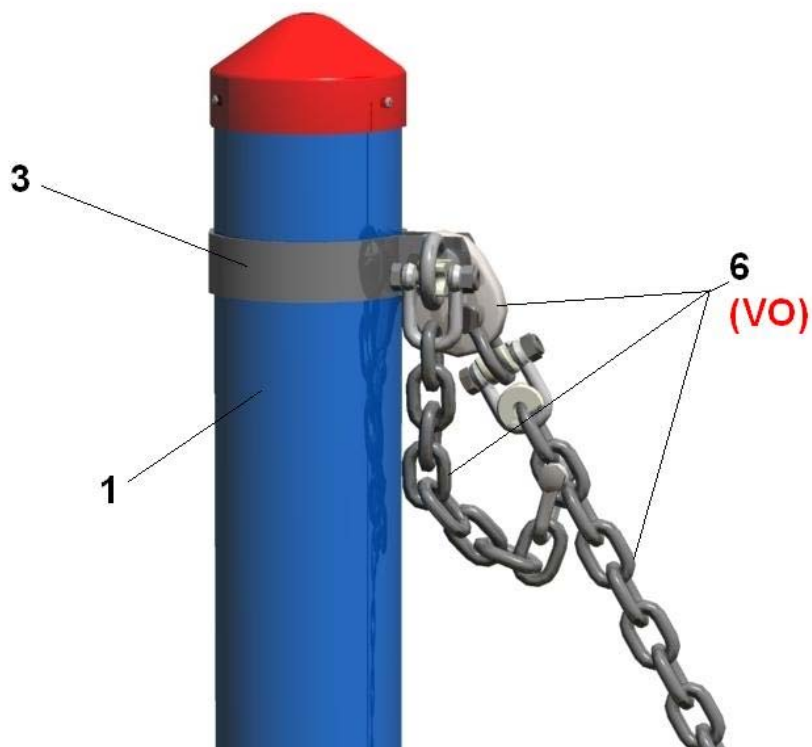
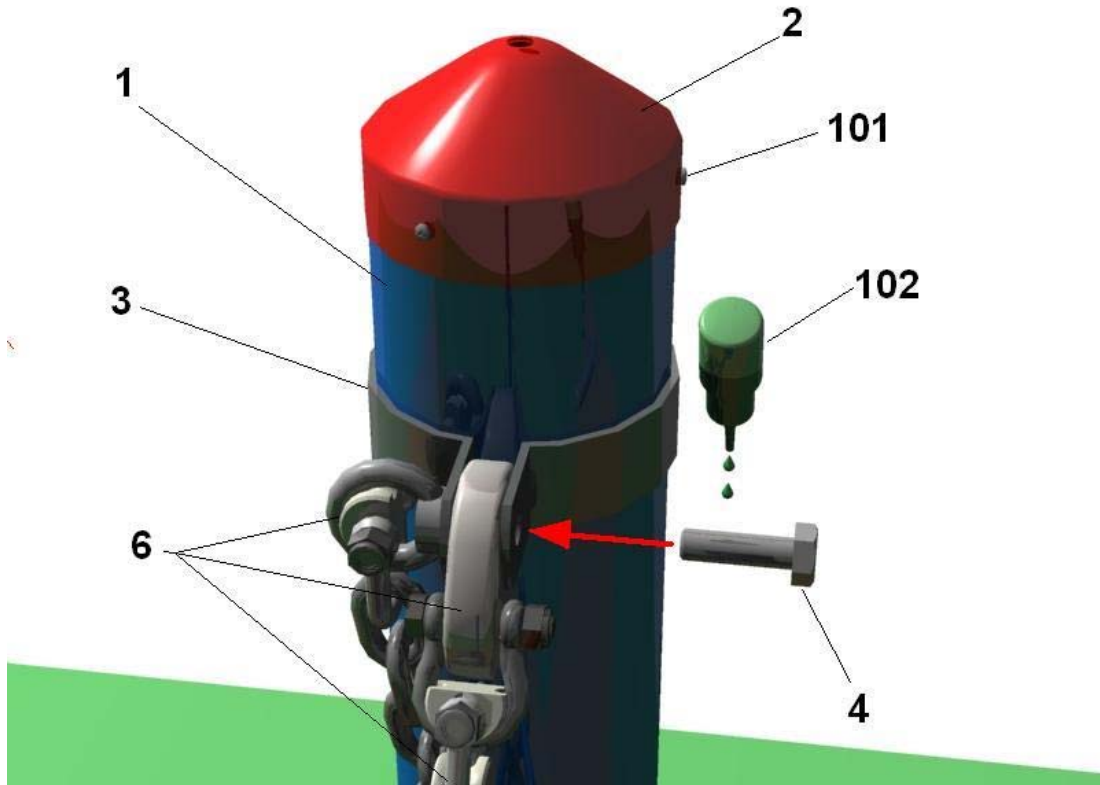

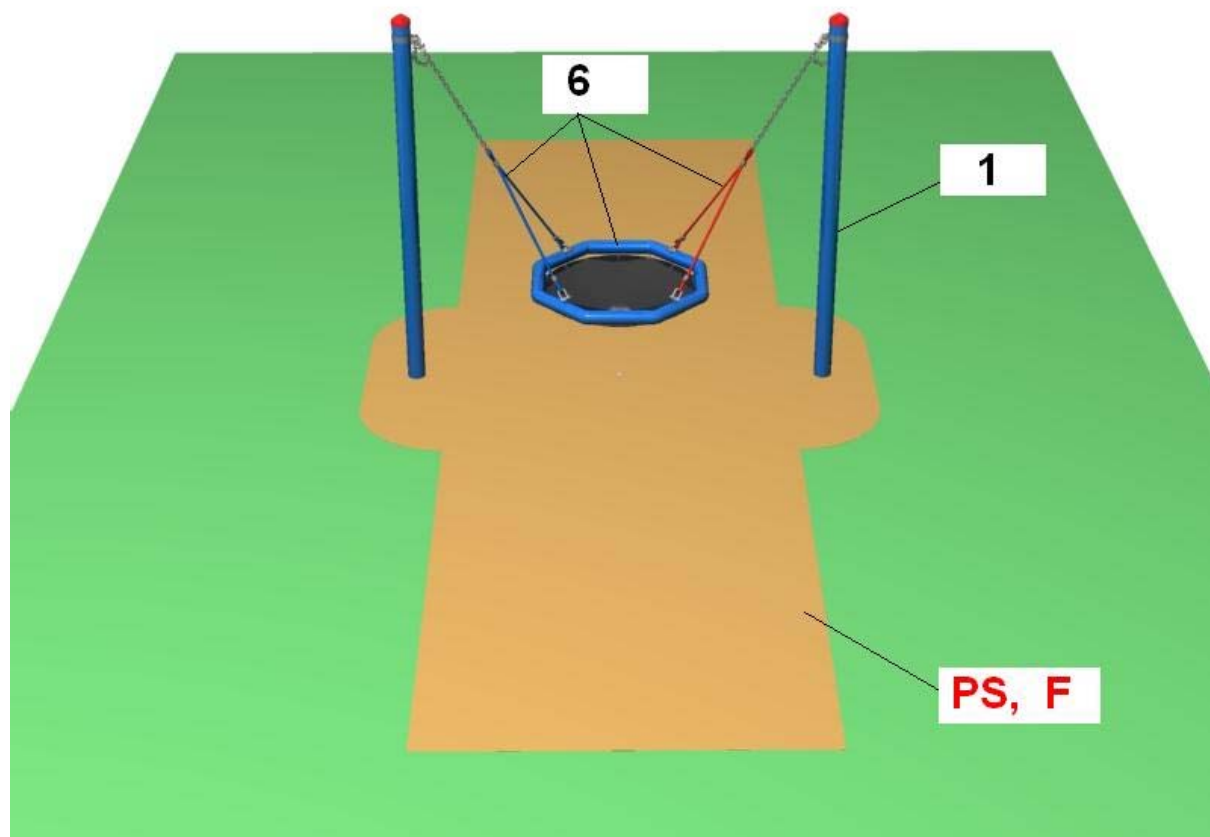

5 Examination after Installation



If the equipment is not installed in a secure manner you must ensure that access is closed to the public!

5.1 Marking the filling level

- Markings on the equipment to indicate filling levels of fall protection material (for example of loose filling material).

5.2 In the following cases the equipment is not yet safely installed:

- safe installation of the equipment is not fully completed
- impact absorbing surface is not installed yet
- the upkeep of occupational safety through appropriate maintenance can not be guaranteed

5.3 Removing assembly accessories

- Please make sure that all accessories, which were used for the installation of the equipment, are removed from the play area! Only then the equipment can be declared open.

5.4 Details concerning inspection of the equipment prior to the first use

- No acceptance test specifications apply prior to first use.

5.5 Retighten bolts

- Please retighten all bolts after one week of initial use. Later, it is sufficient to retighten the bolts upon respective maintenance.

B Maintenance Instructions “Honeycomb Nest” Easy - Swing, Art. 4591-50- 3

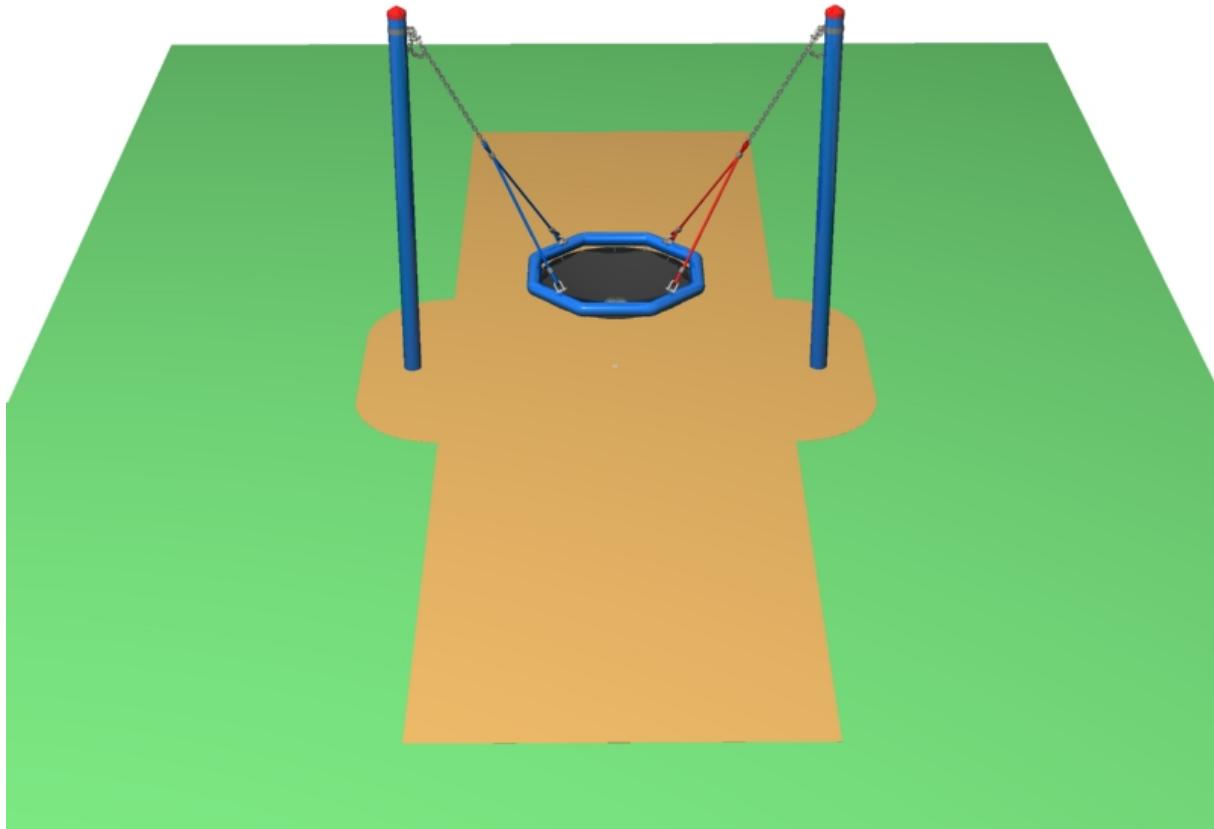

6 Introduction Maintenance

6.1 General information

This equipment should be installed, inspected, maintained and operated in accordance with EN1176-7 guidelines.



Please note: Providing any necessary repairs are carried out, a piece of play equipment that is inspected regularly cannot become so damaged that it is dangerous.

Any spare parts which may be required can be obtained directly from your supplier.



This equipment should only be assembled, maintained and repaired by **persons with the necessary expertise.**

A copy of the inspection record is to be handed over to the operator, who must confirm receipt

This maintenance instruction is based on the standard “EN 1176-1:1998”.

7 General Maintenance Information

7.1 Maintenance intervals

Maintenance intervals are based on average use. Please note that more frequent inspections and/or maintenance are required if the play equipment is subject to intensive use!

7.2 Inspection frequency

The frequency of inspections must be based on actual use. Factors that affect frequency include vandalism, location (e.g. coastal proximity), air pollution and the age of the equipment!

7.3 Maintenance products and procedures

All nuts and bolts are hot-dip galvanised or stainless steel. One of the characteristics of stainless steel is that uncontrolled cold welding may occur when the nuts are tightened. To prevent this, it is necessary to spray the nuts and bolts with Teflon spray (for example HTS plus Teflon no. 893128, can be purchased from the company Würth) or another similar lubricant.

7.4 Spare parts

All spare parts must comply with the manufacturer's specifications!

7.5 Identifying spare parts

All spare parts are listed in the parts list. You find the parts list in chapter 3.

7.6 Special instructions for the disposal of individual equipment components

No special instructions are necessary.

7.7 Special measures in the starting time

No later than 2 weeks after assembly, all screwed connections should be checked and tightened if necessary.

7.8 Special measures in the starting time

No later than 2 weeks after assembly, all screwed connections should be checked and tightened if necessary.

7.9 Maintenance of fall protection surfaces

Surfaces providing fall protection must also be maintained regularly. It is particularly important to maintain the correct level of loose surface material and add more if necessary.

7.10 Faults



Damages must be repaired as soon as they are detected! If serious defects that affect the safety cannot be repaired straight away, the playground equipment must be closed to the public with immediate effect.

7.11 Loose screws



Loose screws always cause quality problems and put safety at risk. Therefore, loose screws should always be tightened and checks should be carried out to ensure that there are no missing screws (watch for see-through holes, for example).

7.12 Preventing equipment use

The use of the equipment should be prevented: in case of incomplete installation, disassembly, maintenance, repairs and faults.

7.13 Guarantee resp. warranty

Steel posts and post shoes are covered by our guarantee if regular maintenance is carried out and recorded in writing. Our general terms and conditions apply. Maintenance of steel poles first takes place after 3 years. The steel posts must be excavated down to the concrete foundations and checked **for corrosion**. Zinc paint should be applied to any corroded areas and scratches. Check ropes for abrasion. Ropes are to be re-impregnated once intensive abrasion occurs.

8 Maintenance Timetable

8.1 Special advices

8.1.1 Maintenance interval

We strongly advise to carry out inspections and maintenance work within the specified periods as use of the equipment, weather and malicious vandalism cause wear and tear that compromise safety and function of the equipment.

8.1.2 Maintenance intervals in the event of intensive use

Please note that more frequent inspections and/or maintenance are required if the play equipment is subject to intensive use!!!

8.1.3 Faults that compromise safety



Notice

In the event of a fault that compromises safety, quick action must be taken: The equipment has to be closed immediately and repaired or dismantled.

8.1.4 Faults that compromise function



Notice

Faults that compromise function should also be repaired immediately. Such faults lower the value of the equipment to the user and encourage malicious vandalism, which may render the equipment less safe. Any damages should be repaired immediately.

9 Regular Maintenance (image)

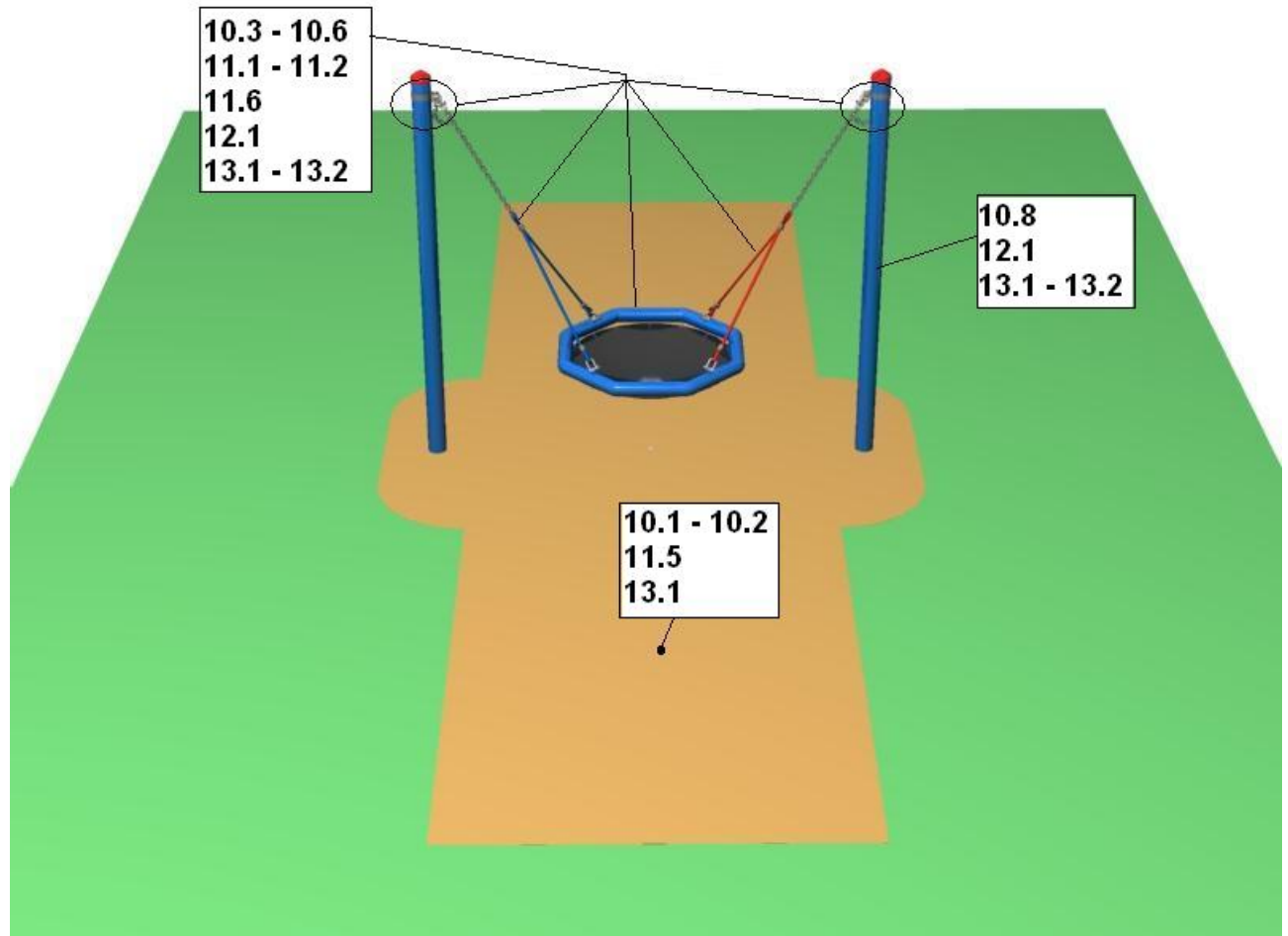

10 Monthly Maintenance (text)

- 10.1 Check the spaces between the equipment and the ground (clearance and height of fall).**
- 10.2 Check the ground surface of fall protection for hard objects and loose foundations.**
- 10.3 Check all connecting elements and fittings for wear and tear and tighten if necessary. Replace damaged or missing parts.**
- 10.4 Check that moving metal parts (joints, springs, etc.) move smoothly and are not worn. Replace if necessary. It is not necessary to lubricate joints as we only use maintenance-free metal roller bearings.**
- 10.5 Check all attachments such as chains, ropes, nets, etc. for damage and replace if necessary.**
- 10.6 Check rubber parts, sleeves, etc. for wear and tear or damage and replace if necessary.**
- 10.7 Check the surface of wooden parts for damage caused by the weather or external influences and mould. Repair or replace if necessary.**
- 10.8 Check the surface of plastic and metal parts, e.g. slides, for damage and replace if necessary.**

11 Quarterly maintenance (text)

- 11.1 Detailed inspection of the operation and stability of the equipment paying particular attention to any wear and tear.**
- 11.2 Tighten all types of fastenings.**
- 11.3 Repaint and retreat surfaces.**
- 11.4 Maintenance of fall protection surfaces.**
- 11.5 Check height of fall protection material and fill up with loose filling material if necessary! If the posts are marked, fill up correspondingly.**
- 11.6 Retighten bolts.**

12 Half-yearly maintenance (text)

- 12.1 The stability of supporting posts, braces, foundations etc. has to be checked. Once repair respectively replacement is completed, the entire equipment has to be verified.**

13 Annual main inspection (text)

13.1 The complete equipment as well as the foundations and the surfaces are to be checked if they are generally safe.

13.2 The equipment is to be verified according to rotting and corrosion. For that some parts might have to be excavated. Zinc paint should be applied to any corroded areas and scratches.



Attention

The equipment must be inspected by someone **with the necessary expertise** in strict compliance with the instructions issued by Huck Seiltechnik GmbH.

A copy of the inspection record is to be given to the operator, who must confirm receipt!

14 Maintenance Printout

Name of equipment: „Honeycomb Nest“ Easy-Swing / Part no. 4591-50-3 _____

Location: _____

Customer or operator: _____

(Town, Council, School, etc)

| Date of inspection | Inspector | OK | Accessible | Closed | Defects | Repaired by | Date |
|--------------------|-----------|----|------------|--------|---------|-------------|------|
| | | | | | | | |
| | | | | | | | |
| | | | | | | | |
| | | | | | | | |
| | | | | | | | |
| | | | | | | | |
| | | | | | | | |
| | | | | | | | |
| | | | | | | | |
| | | | | | | | |
| | | | | | | | |
| | | | | | | | |
| | | | | | | | |

Please copy and return to the manufacturer by Telefax +49 (0)6443 / 83 11 79 once a year after main inspection has been carried out.

Place the confirmation form in your existing play equipment files.

15 Hand Over Document



Attention

After the installation of the equipment, the installation and maintenance documents are to be handed over to the operator. The operator has to have the documents signed. The complete filled and signed hand over documents are to be sent back to the supplier Huck Seiltechnik GmbH via fax +49 (0)6443 / 83 11 79!

Part no.: 4591-50 - 3

Type of equipment: "Honeycomb Nest" Easy – Swing

Serial number: _____

Customer or operator (Town, Council, School, etc.):

Person in charge:

Installation Company (address):

Assistant in charge (assembler):

Complete assembly instruction, maintenance instruction and maintenance printout received,

(Signature operator)
(Stamp)

(Signature Installation Company)

Date: _____