



## You Couldn't Score in a Better Net!

For over 50 years the HUCK-Label has been synonymous for:

- top quality nets and ropes
- innovative solutions
- continuous quality
- state-of-the-art manufacturing techniques

If you want to speak to us in person, we will be happy to see you at:



FSB 2015:

Tuesday, 27. October  
to Friday, 30. October  
in Cologne

International Trade Fair for leisure, sports and swimming facilities.



Ispo 2016:

Sunday, 24. January  
to Wednesday, 27. January  
in Munich

Connecting sport business professionals



## Sport nets and ropes

for all ball games

**Huck Nets (U.K.) Ltd.**  
Gore Cross Business Park  
Corbin Way, Bradpole,  
Bridport • Dorset, DT6 3UX

Tel. (01308) 425 100  
Telefax (01308) 458 109  
E-Mail [sports@hucknetting.co.uk](mailto:sports@hucknetting.co.uk)  
Web [www.huck-net.co.uk](http://www.huck-net.co.uk)



Go online with HUCK NETS:

[www.huck-net.co.uk](http://www.huck-net.co.uk)



RETAIL CATALOGUE NO. 55

2015/2016

Tel. (01308) 425 100  
E-Mail [sports@hucknetting.co.uk](mailto:sports@hucknetting.co.uk)  
Web [www.huck-net.co.uk](http://www.huck-net.co.uk)

# HUCK

## NEW for 2015

**Football net optimised for cameras,  
see page 1.1**

The white side towards the pitch provides a clear outline for players, while the black side towards the stands gives spectators and cameras a great view of the action.



**New volleyball net,  
see page 3.1**

New volleyball net with a 45 mm mesh size allowing, among other things, better net printing.



## 50 years of HUCK

... means 50 years of entrepreneurial spirit and HUCK's focus on quality  
... means 50 years of development in net technology  
... means a good many professional careers.



Dear business associates and sports fans,

You are now holding the new sports net catalogue no. 55, 2015/2016. The first page features football nets with different colours on either side. This colour design is incorporated when the net is being made and offers the added benefit of giving spectators and cameras a great view of the action on the pitch through the black side towards them, while the white side allows players to clearly distinguish the outline of the goal and goal net to "score as many goals as possible".

This is just one of the highlights of the many kinds of pattern options available to us.

Nets made from biodegradable fibre are also among the continual innovations in Manfred Huck GmbH's comprehensive product portfolio.

HUCK's experience from our involvement in international events comes in useful to every buyer of HUCK sports and protective nets.

Trust in our proven HUCK quality, great service and high supply capability.

With best wishes

**HUCK Nets (U.K.) Ltd.**

### Please note our Head Office direct telephone numbers:

**Switch Board** +44 (0)1308 425 100    **Fax** +44 (0)1308 458 109

#### **Board of Directors:**

Stefan Huck  
Richard Connolly  
Bernard Delbaere  
Jon Legg-Bagg

**[www.huck-net.co.uk](http://www.huck-net.co.uk)**

▶ [sports@hucknetting.co.uk](mailto:sports@hucknetting.co.uk)

# Contents

## Football

1.1 – 1.14

Football goal nets optimised for cameras, Football goal nets with chequered patterns, football goal nets made from PLA (polylactic acid), football goal nets with hexagonal mesh, exclusive football goal nets, small-mesh football goal nets, shooting target wall, two-colour football goal nets in club colours, junior football goal nets, mini goal sets, Futsal goal nets, ball carrier nets, football goal net accessories

## Handball/Hockey

2.1 – 2.8

Handball goal nets with hexagonal mesh, handball goal nets with chequered patterns, two-colour indoor handball goal nets in club colours, indoor handball goal nets, handball goal catch nets, handball goal net accessories, indoor hockey goal nets, field and roller hockey goal nets, floorball goal net

## Volleyball

3.1 – 3.6

Volleyball tournament nets approved by the German Volleyball Association, volleyball tournament nets conforming to international regulations, long volleyball nets, volleyball training nets, volleyball antennae, sit volleyball, volleyball net accessories

## Badminton

4.1 – 4.3

Badminton tournament nets, badminton net sets, long badminton nets, badminton training nets, badminton net accessories, ball stop nets

## Tennis

5.1 – 5.10

“Excalibur” and “Merlin” tennis nets, tennis net accessories, tennis court drag mats, tennis practice net, junior tennis nets, tennis court dividing nets, dividing nets in flame-retardant weave, indoor tennis court panelling, tennis court surrounds, printed advertising

## Protection/Safety Nets

6.1 – 6.10

Product information, safety and stop nets, safety and stop net accessories, universal barrier fencing, indoor football nets, partition curtains for gymnasiums, playing-area safety nets, flameretardant impregnated safety nets

## Other Sports

7.1 – 7.12

Basketball nets, ice hockey goal nets, water polo goal nets, cycle ball/cycle polo goal nets, deck tennis nets, indiana nets, sand pit cover nets, hammer throwing and discus safety nets, stop nets/practice tunnels for cricket and baseball, stop nets for golf courses, golf practice nets, stop nets for squash courts, archery stop nets, railing nets, seating and hammocks made of polypropylene and Mahulan netting, hammock frames, net climbing course

## Ropes and Cords

8.1 – 8.8

Isilink cords, skipping ropes for gymnastics, skipping ropes, Double Dutch skipping ropes, neon skipping ropes, beaded jump ropes, tug of war ropes, balancing/circular rope, climbing ropes, rope seat, gymnastic ring sets, lunge reins, fistball ropes, swing ball ropes, prellball bands, sitball cords, gymnastic cords

## Beach & Fun

9.1 – 9.15

Beach volleyball tournament and practice nets, complete beach net kits, beach volleyball accessories, recreational volleyball set, beach badminton, recreational badminton, soccer-tennis nets, junior lawn tennis net, paddle-tennis, beach tennis, beach-combi set, beach handball/boundary marking, beach football/boundary marking, goal and security nets for small pitches and multi-sports facilities according to EN 15312, street basketball, all-weather net, sun sail

## Anti-Vandalism Nets

10.1 – 10.9

Knotless stop nets and practice pitch goal nets with “Mahulan steel” wire-strand core, reinforced Polypropylene volleyball nets, Dralo® volleyball nets, reinforced practice pitch goal nets, Dralo® practice pitch goal nets, nets for playgrounds in residential areas, ball stop modular fencing system, reinforced Dralo® stop nets, technical information on Dralo® nets



No. 10133-26

## Football net optimised for cameras with a different colour design on each side

NEW

The "Fans" football net is great for cameras. The white side towards the pitch provides a clear outline for players, while the black side towards the stands gives spectators and cameras a great view. **Utility model patent application DE 20 2014 101 841 U1**

*Dimensions: 7.50 m wide, 2.50 m high, 200 cm deep top and bottom.*

No. 10133

NEW

**Knotless** goal net in approx. **3.5 mm high tenacity polypropylene**, with hexagonal mesh, **black outside, white inside.**

Colour 26: ● white/black

£ 215.00 per pair

**Other colour combinations available upon request!**



offer

... and with it:  
**Net bag No. 1040**  
(see page 1.14 in our catalogue)

Our football goal nets have the maximum mesh width of 120 mm required by DIN EN 748.

Under the latest issue of DIN EN 748 the EN models are no longer restricted to square meshes, such that DIN EN 748 also covers hexagonal meshes.





No. 1023-02

## Football goal nets with hexagonal mesh

HUCK football goal nets with hexagonal mesh were used during the 2006 world football championship in Germany. As a result of such nets in this special design being well received we now offer an extended range of hexagonal mesh goal nets that includes different depths.

*Dimensions: width 7.50 m, height 2.50 m, top depth 0.80 m, bottom depth 2 m.*

*Dimensions: width 7.50 m, height 2.50 m, top and bottom depth 2 m.*

**No. 1021** **Knotless** goal net in approx. **3.5 mm high tenacity polypropylene**, with **hexagonal mesh**.  
 Colour: ● ○ £ 138.00 per pair

**No. 1023** **Knotless** goal net in approx. **3.5 mm high tenacity polypropylene**, with **hexagonal mesh**.  
 Colour: ○ ● £ 217.00 per pair

**Article 102-02 (top depth 80 cm, bottom depth 150 cm) upon request!**

## Football goal nets with alternating coloration (chequered pattern)

Thanks to a new manufacturing technique we can offer knotless nets with hexagonal mesh and **alternating** coloration.

**European patent no. 22 85 456.**

These nets with chequered pattern can be offered in the following sizes and colour combinations.

*Dimensions: width 7.50 m, height 2.50 m, top depth 0.80 m, bottom depth 2 m.*

**No. 1011** **Knotless** goal net in approx. **3.5 mm high tenacity polypropylene**, with hexagonal mesh (**chequered pattern**).  
 Colour: ● ○ ● ○ ● ○ £ 148.00 per pair



No. 1013-27

*Dimensions: width 7.50 m, height 2.50 m, top and bottom depth 2 m.*

**No. 1013** **Knotless** goal net in approx. **3.5 mm high tenacity polypropylene**, with hexagonal mesh (**chequered pattern**).  
 Colour: ● ○ ● ● ● ● ● ●  
 £ 233.00 per pair

- = 01 = green
- = 02 = white
- = 05 = yellow
- = 21 = white/green
- = 24 = white/blue
- = 27 = white/red
- = 54 = yellow/blue
- = 56 = yellow/black
- = 76 = red/black

**When ordering, please specify which colour you require! (e.g. 1013-21)**



No. 10333-02

## Football Goal Nets – Huck Eco-Nets

HUCK now has textile nets for sports uses, helping to protect the environment.

The nets are made from **PLA** (polylactic acid). PLA is **biodegradable** under environmental conditions that can generally only be found in industrial compost works.

**This means that consumers can use an alternative method of disposal.**

*Dim.: width 7.50 m, height 2.50 m, top depth 0.80 m, bottom depth 1.50 m.*

**No. 1033** **Knotless goal net in approx. 4 mm PLA (polylactic acid).**  
Colour: ○ £ 125.00 per pair

**NEW**

*Dimensions: width 7.50 m, height 2.50 m, top depth 0.80 m, bottom depth 2 m.*

**No. 10331** **Knotless goal net in approx. 4 mm PLA (polylactic acid).**  
Colour: ○ £ 135.00 per pair

**NEW**

*Dimensions: width 7.50 m, height 2.50 m, top depth 2 m, bottom depth 2 m.*

**No. 10333** **Knotless goal net in approx. 4 mm PLA (polylactic acid).**  
Colour: ○ £ 175.00 per pair

**NEW**

● = 01 = green      ● = 04 = blue      ● = 07 = red  
○ = 02 = white      ● = 05 = yellow      ● = 09 = violet  
● = 03 = orange      ● = 06 = black

**When ordering, please specify which colour you require! (e.g. 1051-02)**

Prices excluding VAT

## Football Goal Nets

*Dimensions: width 7.50 m, height 2.50 m, top depth 1 m, bottom depth 3 m.*

**No. 1004** **Knotless goal net in 2.3 mm dia. high tenacity polypropylene.**  
Colour: ● ○ £ 54.45 per pair

**No. 1054** **Knotless goal net in 3 mm dia. high tenacity polypropylene.**  
Colour: ○ £ 72.45 per pair

**No. 1064** **Knotless goal net in 5 mm dia. heavy duty high tenacity polypropylene.**  
Colour: ○ £ 220.50 per pair

**No. 1074** **Knotless goal net in 4 mm dia. high tenacity polypropylene.**  
Colour: ○ ● £ 99.75 per pair

*Dimensions: width 7.50 m, height 2.50 m, top depth 0.80 m, bottom depth 2 m.*

**No. 1041** **Knotless goal net in approx. 4 mm polyester.**  
Colour: ○ £ 163.00 per pair

**No. 1051** **Knotless goal net in approx. 3 mm high tenacity polypropylene.**  
Colour: ● ○ ● ● £ 69.00 per pair

**No. 1061** **Knotless goal net in approx. 5 mm high tenacity polypropylene heavy duty design.**  
Colour: ● ○ £ 221.00 per pair

**No. 1071** **Knotless goal net in approx. 4 mm high tenacity polypropylene.**  
Colour: ● ○ ● ● ● ● ● ● £ 102.00 per pair  
Colour: ● ● ● ● ● ● ● ● £ 113.00 per pair

**Please note: All goal nets can be supplied immediately.**



No. 1063-02

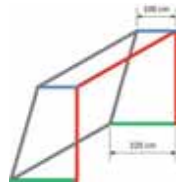

## Football Goal Nets

Dimensions: width 7.50 m, height 2.50 m, top depth 1 m, bottom depth 2.25 m.

- No. 1052** **Knotless goal net in approx. 3 mm high tenacity polypropylene.**  
Colour: ● ○ ● £ 78.00 per pair
- No. 1062** **Knotless goal net in approx. 5 mm high tenacity polypropylene, heavy duty design.**  
Colour: ● ○ £ 232.00 per pair
- No. 1072** **Knotless goal net in approx. 4 mm high tenacity polypropylene.**  
Colour: ● ○ ● ● ● ● £ 108.00 per pair  
Colour: ● £ 119.00 per pair

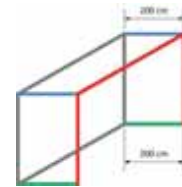

## Football Goal Nets

Dimensions: width 7.50 m, height 2.50 m, top depth 2 m, bottom depth 2 m.

- No. 1043** **Knotless goal net in approx. 4 mm polyester.**  
Colour: ● ○ £ 212.00 per pair
- No. 1053** **Knotless goal net in approx. 3 mm high tenacity polypropylene.**  
Colour: ● ○ ● £ 99.00 per pair
- No. 1063** **Knotless goal net in approx 5 mm high tenacity polypropylene, heavy duty World Cup design.**  
Colour: ● ○ £ 249.00 per pair
- No. 1073** **Knotless goal net in approx. 4 mm high tenacity polypropylene.**  
Colour: ● ○ £ 137.00 per pair



## Net storage bag

offer

- No. 1040** **Net bag**  
– enough space for 1 pair of football goal nets (adult)  
– large opening thanks to a practical double zipper  
£ 12.00 each

- = 01 = green
- = 03 = orange
- = 05 = yellow
- = 07 = red
- = 12 = green/white
- = 72 = red/white
- = 02 = white
- = 04 = blue
- = 06 = black
- = 09 = violet
- = 42 = blue/white

When ordering, please specify which colour you require! (e.g. 1052-04)





No. 1053-045-42

## Small-Mesh Goal Nets (45 mm) – 2coloured

*Dimensions: width 7.50 m, height 2.50 m, top and bottom depth 2 m.*

- No. 1053-045** Knotless goal net in approx. 3 mm high tenacity polypropylene. **Mesh size: approx. 45 mm.**  
 Colour: ● ○ ●      £ 250.00 per pair

The small 45 mm mesh size means that the goal nets are hard to be climbed, in accordance with EN 15312, and also makes them good anti-hooligan nets.

## Small-Mesh Goal Nets (60 mm)

These **anti-hooligan nets** protect the goalkeeper from tins and bottles thrown by the crowd and prevent them being used as climbing nets. **They also add a touch of class to any sports ground.**

*Dimensions: width 7.50 m, height 2.50 m, top depth 0.80 m, bottom depth 2 m.*

- No. 1081-060** Knotless goal net in approx. 4 mm high tenacity polypropylene. Mesh size: approx. 60 mm.  
 Colour: ● ○      £ 174.00 per pair



Goal net with a mesh size of 45 mm to protect the goal keeper from thrown tins, bottles, etc.

*Dimensions: width 7.50 m, height 2.50 m, top depth 1 m, bottom depth 2.25 m.*

- No. 1082-060** Knotless goal net in approx. 4 mm high tenacity polypropylene. Mesh size: approx. 60 mm.  
 Colour: ● ○      £ 187.00 per pair

*Dimensions: width 7.50 m, height 2.50 m, top and bottom depth 2 m.*

- No. 1083-060** Knotless goal net in approx. 4 mm high tenacity polypropylene. Mesh size: approx. 60 mm.  
 Colour: ● ○      £ 229.00 per pair



No. 1081-060-02



No. 1071-45

## Two-Colour Football Goal Nets in Club Colours

With a **greater number of colour combinations**, you can now order even more football goal nets in your club colours!

**Every football field can have an attractive appearance** thanks to the even structure of the netting and the diagonal alignment of the colours.

**In the best Huck quality, of course!**

*Dimensions: width 7.50 m, height 2.50 m, top depth 1 m, bottom depth 3 m.*

**No. 1074** **Knotless goal net in approx. 4 mm high tenacity polypropylene.**

Colour:      
  

£ 109.00 per pair

*Dimensions: width 7.50 m, height 2.50 m, top depth 0.80 m, bottom depth 2 m.*

**No. 1071** **Knotless goal net in approx. 4 mm high tenacity polypropylene.**

Colour:      
  

£ 114.00 per pair

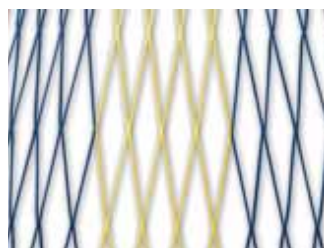

Colour 45: 



Colour 62: 

*Dimensions: width 7.50 m, height 2.50 m, top depth 2 m, bottom depth 2 m.*

**No. 1073** **Knotless goal net in approx. 4 mm high tenacity polypropylene.**

Colour:      
  

£ 170.00 per pair

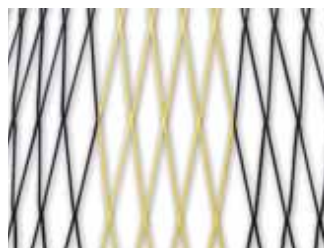

Colour 65: 



Colour 67: 

 = 12 = green/white    = 45 = blue/yellow    = 65 = black/yellow    = 72 = red/white  
 = 42 = blue/white    = 62 = black/white    = 67 = black/red

**When ordering, please specify which colour you require! (e.g. 1071-12)**



No. 1023-72

## Two-colour football goal nets with hexagonal mesh

*Dimensions: width 7.50 m, height 2.50 m, top and bottom depth 2 m.*

- No. 1023**      **Knotless goal net in approx. 3.5 mm high tenacity polypropylene with hexagonal mesh.**  
 Colour:         £ 233.00 per pair

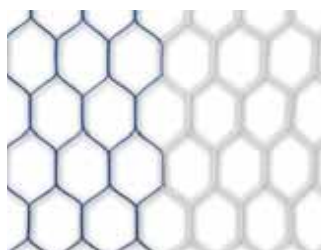

No. 1023-42



No. 1023-72

## Two-colour junior football goal nets

*Dimensions: width 5.15 m, height 2.05 m, top and bottom depth 1 m.*

- No. 151**      **Knotless goal net in approx. 4 mm high tenacity polypropylene.**  
 Colour:         £ 72.00 per pair

*Dim.: width 5.15 m, height 2.05 m, top depth 0.80 m, bottom depth 1.50 m.*

- No. 1515**      **Knotless goal net in approx. 4 mm high tenacity polypropylene.**  
 Colour:         £ 78.00 per pair

*Dimensions: width 5.15 m, height 2.05 m, top depth 0.90 m, bottom depth 2 m.*

- No. 1511**      **Knotless goal net in approx. 4 mm high tenacity polypropylene.**  
 Colour:         £ 78.00 per pair



No. 1515-42



No. 151-05

## Junior Football Goal Nets

### Junior football goal nets in standard German dimensions

*Dimensions: width 5.15 m, height 2.05 m, top and bottom depth 1 m.*

- No. 150** **Knotless goal net in approx. 3 mm high tenacity polypropylene.**  
 Colour: ● ● £ 52.00 per pair
- No. 151** **Knotless goal net in approx. 4 mm high tenacity polypropylene, available in many popular colours.**  
 Colour: ● ○ £ 67.00 per pair  
 Colour: ● ● ● ● £ 72.00 per pair
- No. 152** **Knotless goal net in approx. 5 mm high tenacity polypropylene, heavy duty design.**  
 Colour: ● ○ £ 126.00 per pair

### Junior football goal nets in standard English dimensions

*Dim.: width 6.50 m, height 2.10 m, top depth 1 m, bottom depth 3 m, mesh size 100 mm.*

- No. 1494** **Knotless goal net in approx. 2.3 mm high tenacity polypropylene. Eleven-A-Side Goal net**  
 Colour: ○ £ 50.00 per pair
- Dim.: width 4.80 m, height 1.22 m, top depth 0.50 m, bottom depth 1.20 m, mesh size 100 mm*
- No. 1495** **Knotless goal net in approx. 2.3 mm high tenacity polypropylene. Five-A-Side Goal net**  
 Colour: ○ £ 39.00 per pair

## Junior Football Goal Nets – Huck Eco-Nets

**NEW**

HUCK now has textile nets for sports uses, helping to protect the environment. The nets are made from **PLA** (polylactic acid). PLA is **biodegradable** under environmental conditions that can generally only be found in industrial compost works.

**This means that consumers can use an alternative method of disposal.**

*Dimensions: width 5.15 m, height 2.05 m, top and bottom depth 1 m.*

- No. 15011** **Knotless goal net in approx. 4 mm PLA (polylactic acid).**  
 Colour: ○ £ 80.00 per pair

**NEW**

*Dim.: width 5.15 m, height 2.05 m, top depth 0.80 m, bottom depth 1.50 m.*

- No. 15015** **Knotless goal net in approx. 4 mm PLA (polylactic acid).**  
 Colour: ○ £ 90.00 per pair

**NEW**

Prices excluding VAT



Hexagonal mesh in custom finish (not currently on sale).

## Junior Football Goal Nets

Junior football goal nets in other sizes that conform to the minimum dimensions specified in DIN EN 748

*Dimensions: width 5.15 m, height 2.05 m, top depth 0.90 m, bottom depth 2 m.*

- No. 1501** **Knotless goal net in approx. 3 mm high tenacity polypropylene.**  
Colour: ● ● £ 59.00 per pair
- No. 1511** **Knotless goal net in approx. 4 mm high tenacity polypropylene, available in many popular colours.**  
Colour: ● ○ £ 74.00 per pair  
Colour: ● ● ● ● £ 79.00 per pair
- No. 1541-060** **Small-mesh, knotless goal net in approx. 4 mm high tenacity polypropylene. Mesh size: approx. 60 mm.**  
Colour: ● ○ £ 136.00 per pair

Junior football goal nets that conform to DIN EN 748

*Dim.: width 5.15 m, height 2.05 m, top depth 0.80 m, bottom depth 1.50 m.*

- No. 1505** **Knotless goal net in approx. 3 mm high tenacity polypropylene.**  
Colour: ● £ 58.00 per pair
- No. 1515** **Knotless goal net in approx. 4 mm high tenacity polypropylene, and many more popular colours.**  
Colour: ● £ 74.00 per pair  
Colour: ● ● ● ● £ 79.00 per pair
- No. 1525** **Knotless goal net in approx. 5 mm high tenacity polypropylene, heavy duty design.**  
Colour: ● ○ £ 137.00 per pair
- No. 1545-045** **Close-mesh, knotless goal net in approx. 4 mm high tenacity polypropylene. Mesh size: approx. 45 mm.**  
Colour: ● £ 175.00 per pair

**NEW**

- = 01 = green    ● = 03 = orange    ● = 05 = yellow    ● = 07 = red  
○ = 02 = white    ● = 04 = blue    ● = 06 = black    ● = 09 = violet

When ordering, please specify which colour you require! (e.g. 1511-07)

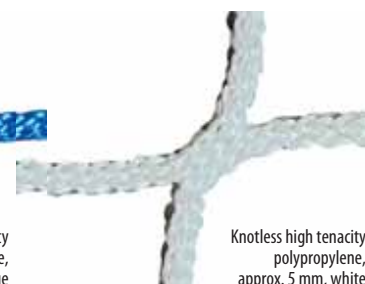
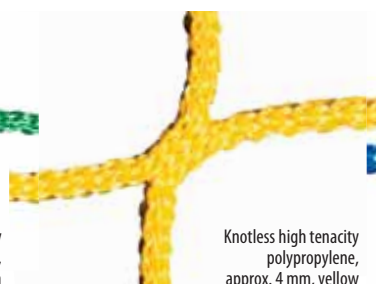
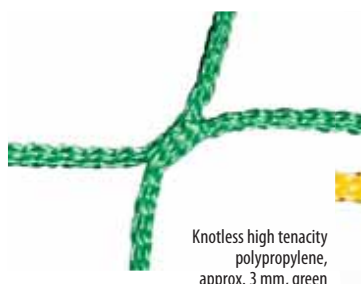



No. 1535-21

## Junior football goal nets with alternating coloration (chequered pattern)

Thanks to a new manufacturing technique we can offer knotless nets with hexagonal mesh and **alternating** coloration.

**European patent no. 22 85 456.**

These nets with chequered pattern can be offered in the following sizes and colour combinations.

*Dimensions: width 5.15 m, height 2.05 m, top and bottom depth 1 m.*

*Dimensions: width 5.15 m, height 2.05 m, top depth 0.80 m, bottom depth 1.50 m.*

**No. 153**      **Knotless** goal net in approx. **3.5 mm high tenacity polypropylene**, with hexagonal mesh (**chequered pattern**).  
Colour: ● ● ●      £ 108.00 per pair

**No. 1535**      **Knotless** goal net in approx. **3.5 mm high tenacity polypropylene**, with hexagonal mesh (**chequered pattern**).  
Colour: ● ● ●      £ 119.50 per pair

## Junior football goal nets with hexagonal mesh

Following the positive feedback from the football World Cup, we have extended our range of junior football goal nets with hexagonal mesh.

*Dimensions: width 5.15 m, height 2.05 m, top and bottom depth 1m.*

**No. 153**      **Knotless** goal net in approx. **3.5 mm high tenacity polypropylene**, with hexagonal mesh.  
Colour: ○ ●      £ 108.00 per pair

*Dim.: width 5.15 m, height 2.05 m, top depth 0.80 m, bottom depth 1.50 m.*

**No. 1535**      **Knotless** goal net in approx. **3.5 mm high tenacity polypropylene**, with hexagonal mesh.  
Colour: ○      £ 119.00 per pair



No. 153-05

● = 01 = green      ● = 05 = yellow      ● = 24 = white/blue  
○ = 02 = white      ● = 21 = white/green      ● = 27 = white/red

**When ordering, please specify which colour you require! (e.g. 151-27)**

Prices excluding VAT



Velcro fasteners for quick and easy fastening of nets to goal, see page 1.14

## Mini Goal Nets

### for goals measuring 1.80 m × 1.20 m

- No. 1200** **Mini goal net** made of approx. 2.3 mm high tenacity polypropylene. **Mesh size: 100 mm.** Includes 2 attachment cords, 8 m long. Dimensions: 1.90 m × 1.30 m, 70 cm deep at the top and bottom.  
Colour: ● £ 32.00 per pair
- No. 1201** **Mini goal net** like item 1200-01 but with a **mesh size of 45 mm.**  
Colour: ● £ 38.00 per pair

### for goals measuring 1.20 m × 0.80 m

- No. 1210** **Mini goal net** made of approx. 2.3 mm high tenacity polypropylene. **Mesh size: 100 mm.** Includes 2 attachment cords, 6 m long. Dimensions: 1.30 m × 0.90 m, 70 cm deep at the top and bottom.  
Colour: ● £ 26.00 per pair
- No. 1211** **Mini goal net** like item 1210-01 but with a **mesh size of 45 mm.**  
Colour: ● £ 36.00 per pair

### for goals measuring 2.40 m × 1.60 m

- No. 1220** **Mini goal net** made of 2.3 mm high tenacity polypropylene. **Mesh size 100 mm.** Includes 2 attachment cords 8 m long. Dimensions: 2.50 m × 1.70 m, top and bottom depth 100 cm.  
Colour: ● £ 42.00 per pair

### for goals measuring 3 m × 1 m

- No. 1221** **Mini goal net** made of 3 mm high tenacity polypropylene. **Mesh size 100 mm.** Includes 2 attachment cords 10 m long. Dimensions: 3 m × 1 m, top and bottom depth 100 cm.  
Colour: ● £ 40.00 per pair



Example of custom-made mini goal net (goal is not available)

### for goals measuring 3 m × 1.60 m

- No. 1222** **Mini goal net** made of 3 mm high tenacity polypropylene. **Mesh size 100 mm.** Includes 2 attachment cords 12 m long. Dimensions: 3 m × 1.60 m, top and bottom depth 100 cm.  
Colour: ● £ 42.00 per pair



No. 108-27

## New trend in sport: Futsal

A completely different version of indoor football. The new trend of Futsal is played, in contrast to normal indoor football, with a special ball.

**Handball goals** are used as goals and we can offer the following net dimensions and qualities.

*Dimensions: width 3,10 m, height 2,10 m, top depth 80 cm, bottom depth 100 cm.*

**No. 108** **Knotless goal net in approx. 3.5 mm high tenacity polypropylene.** With hexagonal mesh and **elastic cords**, to protect external mesh row, **chequered pattern**.  
Colour: ● ● ● £ 81.00 per pair

**No. 114** **Knotless goal net in approx. 4 mm high tenacity polypropylene.**  
Colour: ● ○ ● £ 56.50 per pair



No. 114-01

Anti-vandalism goal nets in Mahulan steel, made from clip nets or Dralo®, a large selection can be found in section 10.



offer

**Net bag No. 1040**  
(see also Page 1.14 in our catalogue)



Goal nets in Mahulan steel (see also page 10.3)

● = 01 = green      ● = 05 = yellow      ● = 24 = white/blue  
○ = 02 = white      ● = 21 = white/green      ● = 27 = white/red

**When ordering, please specify which colour you require! (e.g. 108-21)**

Prices excluding VAT



## Ball Carrier Nets

Ball carrier nets with a **mesh size of approx. 5 cm** in approx. 2.5 mm **high tenacity polypropylene** with pull cord.

A top-quality product **suitable for gymnastic balls**. One-colour.

<b>No. 261</b>	for 1–2 balls	£ 14.00 per pack of 10
<b>No. 263</b>	for 3 balls	£ 14.00 per pack of 10
<b>No. 266</b>	for 6 balls	£ 19.00 per pack of 10
<b>No. 269</b>	for 9 balls	£ 23.00 per pack of 10
<b>No. 2610</b>	for 10–12 balls	£ 28.00 per pack of 10

**Ball carrier as above but in 3 colours (blue/yellow/green)**

<b>No. 269-3F</b>	for 9 balls	£ 24.00 per pack of 10
<b>No. 2613-3F</b>	for 13–15 balls	£ 35.00 per pack of 10

**Small-mesh ball carrier nets in approx. 2 mm high tenacity polypropylene.**

**Mesh size: approx. 3 cm**

<b>No. 2730</b>	for 30 balls	£ 28.00 per pack of 10
Colour:	●	

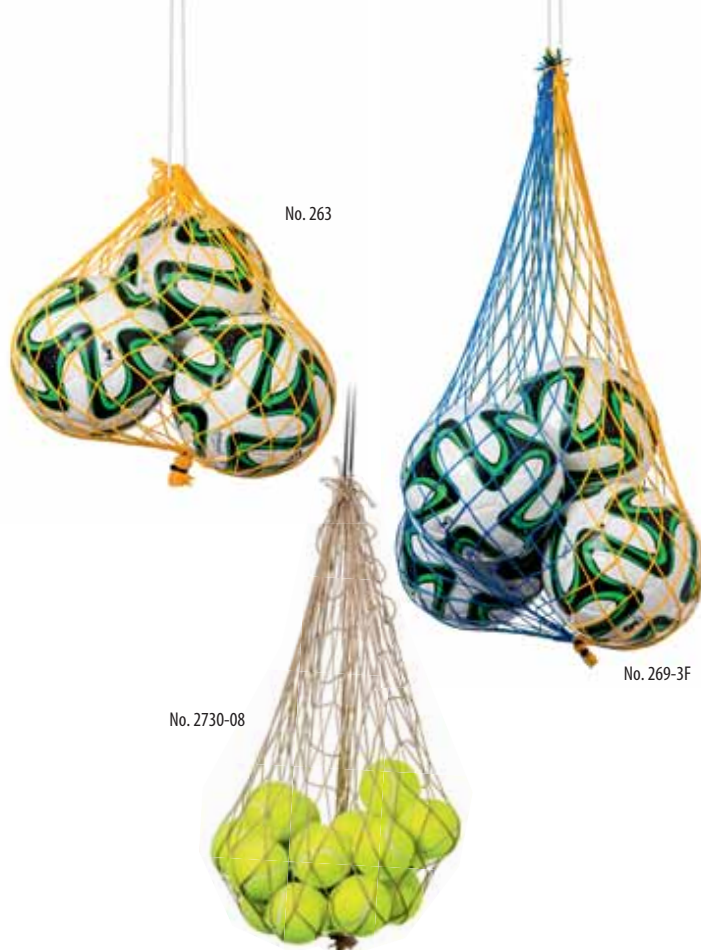

## Shooting Target Wall

**No. 165** Shooting target wall made of polyethylene fabric, approx. 200 g/m<sup>2</sup>, with two target holes approx. 50 cm in diameter, eyelets at the sides and along the top and complete with two 10 m Isilink cords.

**Size: 5 m × 2 m.**

Colour: ● £ 164.00 each

**No. 166** Shooting target wall like No. 165-04 but 3 m × 2 m in size.

Colour: ● £ 99.00 each



No. 165-04

## Multi-sport nets

**Public areas, school grounds, wherever young people are having fun and are able to pursue leisure activities, such as football, basketball etc. in a risk-free environment.**

Nets in high tenacity polypropylene. Available according to every type of sport in various thicknesses, mesh sizes and colours.

**Prices and sizes on request**



Multi-sport facility

**Goal nets according to EN 15312 „Freely accessible multi-sports complexes“;** see Page 9.13 in our catalogue.

## Accessories

### Fixing kits for goal nets.

#### Plastic net hooks

- No. 1010** Plastic net hooks for aluminium goals. £ 14.00 per pack of 10
- No. 10101** Plastic net hooks, black £ 25.00 per pack of 10  
(for nets from 4.5 mm in diameter)

#### Screw hooks for aluminium goals, in stainless steel with aluminium couplings.

- No. 1011** with rectangular couplings £ 24.00 per pack of 10
- No. 1012** with rhombic couplings £ 24.00 per pack of 10



No. 1012



No. 1011



No. 10101



No. 1010

## Support poles + accessories

### Support poles for free hanging goal nets

(goal nets with an equal top and bottom depth).

- No. 1015** **Aluminium support poles**, 40 mm in diameter, total length: 3 m. Set consisting of 2 support poles (in sections) and one ground anchor and tension cord per pole. £ 78.00 per set per goal



No. 1015



No. 1014

- No. 1014** **Net ties**, approx 375 mm long and 7.6 mm wide, for fixing the goal net to the base frame and/or folding frame. Supplied in bags of 100.

Colour: ● £ 21.00 per bag

- No. 10141** **Net ties**, like no. 1014, but packaged in lots of 10.

Colour: ● £ 3.00 per pack of 10

Particularly well suited for public areas, where the net will often have to be taken off and on.

- No. 10145** Velcro strip, width approx. 20 mm, 5 m roll.

Colour: ● £ 11.00 per roll



No. 10145-06

## Net storage bag

offer

- No. 1040** **Net bag**  
– enough space for 1 pair of football goal nets (adult)  
– large opening thanks to a practical double zipper  
£ 12.00 each



## Ballast Chains for Goal Nets

Ballast chain for goal nets, consisting of a chain, 800 g per metre, sheathed in plastic.

- No. 1017** Depth 150 cm  
**Length 10.50 m** £ 109.00 each
- No. 10171** Depth 200 cm  
**Length 11.50 m** £ 120.00 each
- No. 10172** Depth 225 cm  
**Length 12 m** £ 126.00 each

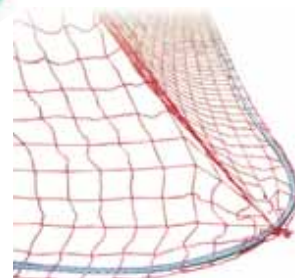

Ballast chain

Prices excluding VAT



No. 111-05

## Indoor handball goal nets with hexagonal mesh

**HUCK** handball goal nets were used during the 2007 world handball championship in Germany and the 2011 world handball championship in Sweden. Goal nets in a special hexagonal mesh design, which stood out additionally by being yellow, were selected.

*In regulation dimensions: width 3.10 m, height 2.10 m, top depth 0.80 m, bottom depth 1 m. Mesh size 10 cm.*

**No. 111**      **Knotless** goal net in approx. **4.75 mm high tenacity polypropylene**, with **hexagonal mesh**, and additional cord to predict the outer rows of mesh.  
Colour: ●      £ 126.00 per pair

**No. 108**      **Knotless** goal net in approx. **3.5 mm high tenacity polypropylene**, with hexagonal mesh, and additional cord to predict the outer rows of mesh.  
Colour: ○      £ 77.00 per pair

## Knotless indoor handball goal nets

**Knotless indoor handball goal nets in high tenacity polypropylene and polyester offer the following advantages:**

- High mesh rigidity and high energy absorption
- Easy-to-put-up nets due to lightweight and flexible net structure
- Looks good
- Accurate mesh size due to form-fit net mesh connections
- Little wear/high abrasion resistance

Our handball goal nets fulfil the requirements of **DIN EN 749!**

They come in a **wide range of colours**, also **including 2-colour** team colours (see pages 2.2 and 2.4).



### Net storage bag

offer

**No. 1040**      **Net bag**  
– enough space **for 1 pair of goal nets**  
– large opening thanks to a practical double zipper  
£ 12.00 each

○ = 02 = white

● = 05 = yellow

**When ordering, please specify which colour you require! (e.g. 111-05)**



No. 108-21

## Handball goal nets with alternating coloration (chequered pattern)

Thanks to a new manufacturing technique we can offer knotless nets with hexagonal mesh and **alternating** coloration.  
**European patent no. 22 85 456.w**

These nets with chequered pattern can be offered in the following colour combinations.

*In regulation dimensions:*

*width 3.10 m, height 2.10 m, top depth 0.80 m, bottom depth 1 m. Mesh size 10 cm.*

- No. 108** **Knotless** goal net in approx. **3.5 mm high tenacity polypropylene, with hexagonal mesh** and additional cord to protect the outer rows of mesh.  
**Chequered pattern**  
 Colour: ● ● ● ● £ 81.00 per pair

## "Ultra" handball net

**NEW**

*In standard dimensions:*

*width 3.10 m, height 2.10 m, top depth 0.80 m, bottom depth 1 m. Mesh size 10 cm.*

- No. 1099** **Knotless** goal net in approx. **4.9 mm PE in braided cord/ braiding technology, with increased abrasion resistance** and a fixed cord to protect the outer mesh rows.  
**NEW**  
 Colour: ● ● ● ● £ 200.00 per pair



No. 1099-06

- = 01 = green      ● = 04 = blue      ● = 06 = black      ● = 24 = white/blue  
 ○ = 02 = white      ● = 05 = yellow      ● = 21 = white/green      ● = 27 = white/red

**When ordering, please specify which colour you require! (e.g. 108-27)**

Prices excluding VAT



No. 109/1091-01

## Indoor Handball Goal Nets

*In regulation dimensions:  
width 3 m, height 2 m, top depth 0.80 m, bottom depth 1 m. Mesh size 10 cm.*

- No. 109** **Knotless 'World Cup'** goal net in approx. **5 mm high tenacity polypropylene**, attached to the goal frame by a fixed cord to protect the outer rows of mesh.  
Colour: ● ○ ● £ 126.00 per pair
- No. 112** **Knotless** goal net in approx. **3 mm high tenacity polypropylene**.  
Colour: ● £ 43.00 per pair
- No. 113** **Knotless** goal net in approx. **4 mm polyester**.  
Colour: ○ £ 106.00 per pair
- No. 114** **Knotless** goal net in approx. **4 mm high tenacity polypropylene**.  
Colour: ● ○ ● £ 56.50 per pair

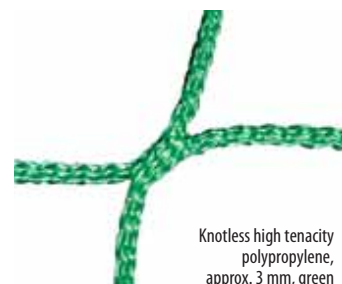

Knotless high tenacity polypropylene, approx. 3 mm, green



Knotless high tenacity polypropylene, approx. 4 mm, yellow

*Dimensions: width 3.10 m, height 2.10 m,  
top depth 0.80 m, bottom depth 1.50 m. Mesh size 10 cm.*

- No. 1142** **Knotless** goal net in approx. **4 mm high tenacity polypropylene**.  
Colour: ● £ 66.00 per pair

*Dimensions: width 3.10 m, height 2.10 m,  
top depth 0.80 m, bottom depth 2 m. Mesh size 10 cm.*

- No. 1143** **Knotless** goal net in approx. **4 mm high tenacity polypropylene**.  
Colour: ● £ 72.00 per pair

**Indoor handball goal nets with different depths on request!**





No. 114-72

## Two-colour handball goal nets in club colours

In order to increase the customer appeal of our handball goal nets, we can now offer you two-colour handball goal nets in your club colours in three colour combinations.

*In regulation dimensions:  
width 3.10 m, height 2.10 m, top depth 0.80 m, bottom depth 1 m. Mesh size 10 cm.*

- No. 114** **Knotless goal nets in approx. 4 mm high tenacity polypropylene.**  
Colour:    £ 63.00 per pair

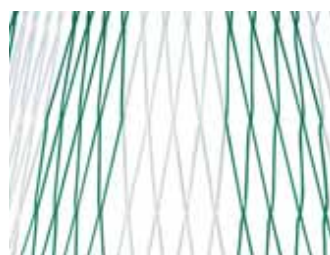
Colour 12: Colour 42: 

## Accessories: Tension cords for indoor handball goal nets

**These tension cords fit all our indoor handball and indoor hockey goal nets.**

- No. 1192** **Elastic tension cords**, 2 heavy-duty elastic cords **with hooks at both ends, 6.50 m long**. These tension cords are designed for the section of net attached to the vertical posts and crossbar of indoor handball and indoor hockey goals (the red lines on the sketch). They make the net more elastic and prolong its life.  
£ 13.00 per pair
- No. 1191** **Tension cords** in approx. **6 mm polyethylene**. A set of 4 cords. The top two tension cords are fitted with a quick-release fastener. These tension cords are for goals in which the net is freely suspended inside the frame (the blue lines on the sketch).  
£ 15.00 per set

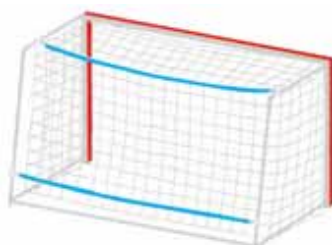

No. 1191 blue, No. 1192 red

**Fixing kits for goal nets.**

**Plastic net hooks**

- No. 1010** Plastic net hooks for aluminium goals. £ 14.00 per pack of 10
- No. 10101** Plastic net hooks, black £ 25.00 per pack of 10  
(for nets from 4.5 mm in diameter)



No. 10101



No. 1010

Prices excluding VAT



No. 111-05

## "Exclusive" Indoor Handball Goal Nets

In addition to the tension cord at the top, these nets have a tension cord at the bottom to prevent the ball from slipping between the goal frame and the net. The tension cord at the top is fitted with a quick-release fastener.

The section of the net that is hung on the goal frame is fitted **with an additional cord in order to protect the outer rows of mesh.**

**Please use the cord and not the net edge to attach the net to the goal frame. This will lengthen the life of the net considerably!**

*In regulation dimensions: width 3.10 m, height 2.10 m, top depth 0.80 m, bottom depth 1 m. Mesh size 10 cm.*

**No. 1131**     **Knotless goal net in approx. 4 mm polyester.**  
Colour: ○     £ 129.00 per pair

**No. 1091**     **Knotless goal net in approx. 5 mm heavy duty, high tenacity polypropylene.**  
Colour: ● ○ ●     £ 143.00 per pair

**No. 1141**     **Knotless goal net in approx. 4 mm high tenacity polypropylene.**  
Colour: ● ○ ●     £ 76.00 per pair



Tension cord with quick-release fastener

- = 01 = green     ●○ = 12 = green/white
- = 02 = white     ●○ = 42 = blue/white
- = 04 = blue     ●○ = 72 = red/white
- = 07 = red



Additional cord to protect the outer rows of mesh

**When ordering, please specify which colour you require! (e.g. 1141-07)**

Prices excluding VAT

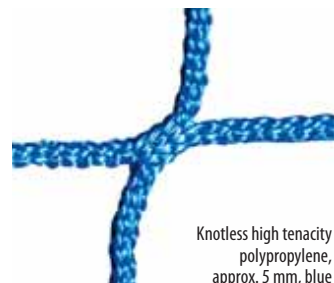
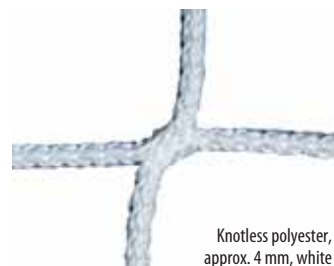

## Catch Nets for Indoor Handball Goals

Dimensions: **2 × 3 m, mesh size 10 cm**, complete with 8 m tie cord. Like in ice hockey, additional catch nets are suspended in indoor handball goals. For a surcharge, all 3 designs can also be **weighted with a lead cord** (see below), which makes the net even more effective at catching balls.

**No. 117** Catch net in approx. **4 mm high tenacity polypropylene**.  
Colour: ● £ 41.00 per pair

**No. 118** Catch net in approx. **4 mm polyester**.  
Colour: ○ £ 52.00 per pair

**No. 119** Catch net in approx. **5 mm high tenacity polypropylene**, suitable for indoor handball goal nets 109 and 1091.  
Colour: ● ○ ● £ 79.00 per pair

## Catch nets for Indoor Handball Goals, close mesh

This catch net has a **mesh size of 4.5 cm** and is fitted **with leaded ballast cord** at the bottom. It has already proven its worth at international tournaments with the ball rolling in and being picked up more easily

**No. 1171** Catch net in approx. **4 mm high tenacity polypropylene**.  
**Mesh size: 4.5 cm**  
Colour: ● ○ ● £ 117.00 per pair

**NEW**

**NEW**

## Weighting for Indoor Handball and Indoor Hockey Goal and Catch Nets

**No. 2110** **Lead cord** weighting for indoor handball catch and goal nets, 400 g per metre. Already fitted in the webbing of the net.  
£ 5.00 per metre

**No. 1193** **Chain weights** for indoor handball goal nets, 800 g per metre. Sheathed in plastic with a hook and tie cord at both ends. For nets with a depth of 1 m.  
Length: 5 m £ 51.00 each



No. 1193

Prices excluding VAT





No. 126-01

## Indoor Hockey Goal Nets

Mesh size 4.5 cm. Dimensions: width 3 m, height 2 m, top depth 0.80 m, bottom depth 100 cm.

As the goal net dimensions for indoor handball and indoor hockey are identical, the same nets can be used for both sports!

- |  |   |
|--|---|
| <p><b>No. 110</b>     <b>Knotless</b> Indoor hockey goal net in approx. <b>4 mm high tenacity polypropylene</b>. Mesh size: 4.5 cm.<br/>           Colour: ●     £ 170.00 per pair</p> | <p><b>No. 126</b>     <b>Knotless</b> Indoor hockey goal net in approx. <b>5 mm heavy duty, high tenacity polypropylene</b>. Mesh size 4.5 cm.<br/>           A very flexible net.<br/>           Colour: ● ○ ●     £ 231.00 per pair</p> |
| <p><b>No. 125</b>     <b>Knotless</b> Indoor hockey goal net in approx. <b>3 mm high tenacity polypropylene</b>. Mesh size 4.5 cm.<br/>           Colour: ●     £ 129.00 per pair</p>  | <p><b>No. 127</b>     <b>Knotless</b> Indoor hockey goal net in approx. <b>2.5 mm high tenacity polypropylene</b>. Mesh size 2.5 cm.<br/>           Colour: ●     £ 231.00 per pair</p>   |

All indoor hockey goal nets have an additional cord in the goalmouth area.

The goal nets should only be attached to this cord as this lengthens the life of the nets considerably (see photo right).



Additional cord for the protection of mesh edge

## Mini hockey goal net

Mini hockey goal net in approx. 2 mm high tenacity polypropylene.  
 Mesh size 4.5 cm. Available in any size.     Price on request.

See page 1.11 for our mini goal nets.

● = 01 = green   ○ = 02 = white   ● = 04 = blue   ● = 05 = yellow

When ordering, please specify which colour you require! (e.g. 119-04)



No. 130-01

## Field Hockey Goal Nets

### Field hockey goal net with a mesh size of 4.5 cm.

**No. 130** **Knotless** field hockey goal net in approx. **3 mm high tenacity polypropylene**. Mesh size 4.5 cm, width 3.66 m, height 2.14 m, top depth 90 cm, bottom depth 120 cm.

Colour: ● £ 128.00 per pair

**No. 1301** **Knotless** field hockey goal net in approx. **4 mm high tenacity polypropylene**. Mesh size 4.5 cm, width 3.66 m, height 1.80 m, top depth 90 cm, bottom depth 120 cm.

**In this case the net only comes down as far as the backboard (at the sides and back).**

Colour: ● £ 219.00 per pair

**No. 1302** **Knotless** field hockey goal net as no. 1301, but in approx. **3 mm high tenacity polypropylene**, mesh size 4,5 cm.

Colour: ● £ 159.00 per pair

### Field hockey goal net with a mesh size of 2.5 cm.

**No. 132** **Knotless** field hockey goal net in approx. **2.5 mm high tenacity polypropylene**. Mesh size 2.5 cm, dimensions as No. 130.

Colour: ● £ 266.00 per pair

● = 01 = green    ○ = 02 = white

When ordering, please specify which colour you require! (e.g. 137-02)

See page 7.2 for our ice hockey goal nets.

## Roller Hockey Goal Nets

**No. 131** **Knotless** roller hockey goal net in approx. **3 mm polyester**. Mesh size 4 cm. Dimensions: 170 cm wide, 105 cm high, **top depth 35 cm, bottom depth 92 cm**, including a hook-on net: 180 × 110 cm. Colour: ○ £ 162.00 per pair

**No. 1311** **Knotless** roller hockey goal net in approx. **4 mm polyester**. Mesh size 4 cm. Dimensions: 170 cm wide, 105 cm high, **top depth 65 cm, bottom depth 110 cm**, including a hook-on net: 180 × 110 cm. Colour: ○ £ 195.00 per pair

## Floorball

**No. 136** **Knotless** floorball net in approx. **2.3 mm high tenacity polypropylene**. Mesh size 45 mm, 1.60 × 1.15 m, top depth 40 cm, bottom depth 60 cm.

Colour: ○ £ 37.00 per pair

**No. 137** **Knotless** floorball net (which hooks on) in approx. **2.3 mm high tenacity polypropylene**.

Mesh size 45 mm, 1.70 × 1.25 m.

Colour: ○ £ 16.00 per pair

Please measure the depth of the goal before ordering to avoid delivery of an unsuitable net.



Floorball Goal Net



## Volleyball Tournament nets that meet international and DVV I standards

These nets are used for international matches as well as for all competition matches, particularly in the higher categories, from the Landesliga (German State League) and above. They all share the following features:

- **6-point suspension** with 3 quick-release fasteners at each end and fibreglass-reinforced polyester rods sewn into the sides
- **70 mm wide, white headband** with 11.70 m Kevlar cable
- continuous **50 mm wide, white band** along the bottom

*9.50 m long, 6-point suspension, fibreglass-reinforced polyester rods sewn into the sides at each end and Kevlar cable (11.70 m long) above with a 70 mm headband and a continuous 50 mm band along the bottom.*

**No. 5088**      **Knotless volleyball tournament net in approx. 3 mm high tenacity polypropylene, mesh size: 100 mm.**  
Colour: ●      £ 112.00 each

**No. 5055**      **Knotless volleyball tournament net in approx. 2.3 mm high tenacity polypropylene, mesh size 45 mm.**  
Colour: ●      £ 110.00 each

**NEW**

**No. 5077**      **Knotless volleyball tournament net in approx. 4 mm high tenacity polypropylene, mesh size: 100 mm.**  
Colour: ●      £ 118.00 each



No. 5055-06

All volleyball nets are fitted with a plastic disc at both ends of the net, to prevent the steel or Kevlar cable from accidentally slipping back into the tape.

Our tournament nets (without printing) have a **woven, extremely heavy-duty** headband. The nets are 9.50 m long and 1 m high, and conform to DIN EN 1271, **Net class A (issued January 2015)** requirements.

**We cannot issue quotes for nets with printed edges (on PVC bands) until we have camera-ready artwork.**

**Depending on the size of the order, there may be a substantial surcharge for this service and delivery is likely to be 3-4 weeks after approval of the print format.**

**Please note: If Kevlar cables in other lengths are needed, please state this when ordering!**

**When ordering, please specify which colour you require!**

(e.g. 5088-06)      ● = 06 = black

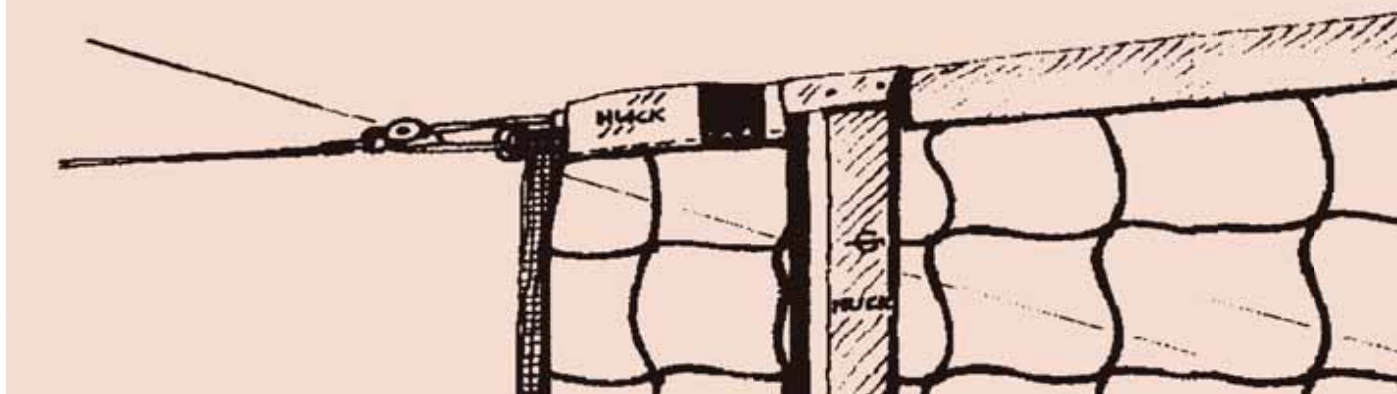

No. 5099: Volleyball Tournament DVV I competition nets. The pulley on each side of the net ensures a perfectly even tension over the entire area of the net.

## Volleyball Tournament Nets that conform to DVV I standards (with tension pulley)

9.50 m long, **6-point suspension**, fibreglass-reinforced polyester rods sewn into the sides at each end and Kevlar cable (11.70 m long) with tension pulley above. **70 mm wide headband and continuous 50 mm wide band** along the bottom.

**No. 5099** This design development **patented by Huck (patent no. P 43 24 767.9-09)** also features a tension pulley at both ends of the Kevlar cable. This system guarantees an even tension across the net. It is also possible to adjust the position of the net to fit the court markings once it has been tensioned.

„Smash“ **knotless** volleyball tournament net in approx. **3 mm high tenacity polypropylene** with Kevlar tension cord (11.70 m long), fibreglass-reinforced polyester rods sewn into the sides at each end, **6-point suspension** and 6 tie cords with quick-release fastener as well as a **tension pulley** at each end.

Colour: ● £ 129.00 each

## Volleyball Tournament nets that meet international and DVV II standards

9.50 m long, **4-point suspension**, fibreglass-reinforced polyester rods sewn into the sides at each end and steel or Kevlar cable (11.70 m long) with a **70 mm headband** and continuous **50 mm band** along the bottom.

**No. 5033** **Knotless** volleyball tournament net in approx. **3 mm high tenacity polypropylene** with **steel cable** (approx. 4 mm thick and 11.70 m long). Fibreglass-reinforced polyester rods sewn into the sides at each end, **4-point suspension** and 4 tie cords with quick-release fastener.

Colour: ● £ 91.00 each

**No. 5034** **Knotless** volleyball tournament net in approx. **3 mm high tenacity polypropylene** with **Kevlar cable** (approx. 5 mm thick and 11.70 m long). Fibreglass-reinforced polyester rods sewn into the sides at each end, **4-point suspension** and 4 tie cords with quick-release fastener.

Colour: ● £ 98.00 each



No. 5034-06

**Please note: If Kevlar or steel cables in other lengths are needed, please state this when ordering!**



No. 5166: The bottom of the net is reinforced beyond the playing area so that the antenna pockets can be secured properly. DVV-Approved for items 5133-06, 5134-06 and 5166-06.

## DVV-Approved Volleyball Tournament Nets

In contrast to DVV I and DVV II, DVV nets have a 50 mm wide headband and, at the bottom, a band for securing the antennae only at the sides. They can still be used as tournament nets in the lower divisions.

*9.50 m long, 4-point suspension, fibreglass-reinforced polyester rods sewn into the sides at each end and steel or Kevlar cable (11.70 m long) above.*

*9.50 m long, 6-point suspension, fibreglass-reinforced polyester rods sewn into the sides at each end and Kevlar cable (11.70 m long) above.*

**No. 5133** **Knotless** volleyball tournament net in approx. **3 mm high tenacity polypropylene** with **steel cable** (approx. 4 mm thick and 11.70 m long). Fibreglass-reinforced polyester rods sewn into the sides at each end, **4-point suspension** and 4 tie cords with quick release fastener.  
Colour: ● £ 75.00 each

**No. 5166** **Knotless** volleyball tournament net in approx. **3 mm high tenacity polypropylene** with **Kevlar cable** (11.70 m long). Fibreglass-reinforced polyester rods sewn into the sides at each end, **6-point suspension** and 6 tie cords with quick-release fastener.  
Colour: ● £ 96.00 each

**No. 5134** **Knotless** volleyball tournament net in approx. **3 mm high tenacity polypropylene** with Kevlar cable (approx. 5 mm thick and 11.70 m long). Fibreglass-reinforced polyester rods sewn into the sides at each end, **4-point suspension** and 4 tie cords with quick release fastener.  
Colour: ● £ 82.00 each

## Long Volleyball Nets (for training)

**No. 5030** **Knotless** long volleyball net in approx. **3 mm high tenacity polypropylene** with polyester headband. Kevlar cable length: net length + 2 m  
Colour 06: Black £ 7.00 per metre

**No. 5020** **Knotless** long volleyball net in approx. **2.3 mm high tenacity polypropylene** with polyester headband. Kevlar cable length: net length + 2 m  
Colour: ● £ 6.00 per metre



No. 5030-06

**When ordering, please specify which colour you require!** (e.g. 5133-06)

● = 06 = black

## Volleyball Training Nets

Regulation dimensions: 9.50 m long, 1 m high, mesh size 10 cm, steel or Kevlar cable, or nylon tie cord (11.70 m long).

- |  |  |
|--|--|
| <p><b>No. 509</b> Volleyball net in approx. <b>2 mm polyethylene cord</b>, 9.50 m long, 1 m high, <b>with nylon tie cord</b>.<br/>Colour: ● £ 25.00 each</p> | <p><b>No. 503</b> Volleyball net in approx. <b>3 mm high tenacity polypropylene</b> with <b>4 mm steel cable</b>. Heavy-duty design.<br/>Colour: ● ● £ 48.00 each</p>    |
| <p><b>No. 501</b> Volleyball net in approx. <b>2 mm polyethylene cord</b> with <b>3 mm steel cable</b>.<br/>Colour: ● £ 33.00 each</p>                       | <p><b>No. 5032</b> Volleyball net in approx. <b>3 mm high tenacity polypropylene</b> with <b>11.70 m Kevlar cable</b>. Heavy-duty design.<br/>Colour: ● £ 56.00 each</p> |

The reinforced edges of all training nets are made of high quality UV-resistant material.

When ordering, please specify the colour of the net!

e. g. 503-01 = Volleyballnet in colour green.

● = 01 = green ● = 06 = black

### "Exclusive" Training Net

- No. 5011** Volleyball net in approx. **2.3 mm high tenacity polypropylene**, reinforced all round with tarpaulin, 11.70 m steel cable above, fibreglass-reinforced polyester rods sewn into the sides, additional tie cords on all four corners.  
Colour: ● £ 55.00 each



No. 5011-06

### Quick Assembly Training Nets

With school volleyball in mind, we have designed a practice net that can be set up very quickly (1 minute). It is made of polyethylene Raschel fabric and is approx. 70 cm high. There is a 50 cm long elastic loop in each corner but no steel cable or reinforced surround.

- No. 511** Training net for quick assembly, **length 10 m**.  
Colour: ● with white selvage £ 24.00 each
- No. 512** Training net for quick assembly, **length 3.50 m**.  
Colour: ● with white selvage £ 16.00 each

Other lengths available upon request.

### ... and the professional versions:

- No. 515** Training net for quick assembly, 0.40 × 10 m, made of **reinforced Raschel fabric with reinforced headband**. Tensioning of the net is improved by PES rods at the sides, the tension cord with Clamcleat cleat along the top and elastic loops with snap hooks fitted at the bottom on both sides.  
Colour: ● £ 39.00 each



No. 511



No. 515-01

Items 509–515 cannot be supplied with steel or Kevlar cables.



## Volleyball Antennae

According to the rules of international volleyball, antenna pockets must incorporate a white strip, 5 cm wide, which serves as a boundary marker, and a black pouch for the antenna. The white boundary marker and black pouch must form a complete unit (see photos).

- No. 502**      **One-piece volleyball antennae** with DVV approval. Length 1.80 m. Supplied **complete with coated polyester pockets** and boundary marker. £ 32.00 per pair
- No. 5021**    **Two-piece volleyball antennae**. Length 1.80 m. Supplied complete like item 502. DVV approved. **Improved design: the join is extremely stable, which increases the stability of the equipment (see photo in the bottom right-hand corner).** £ 35.00 per pair



The new woven Polyester support pocket can even withstand extreme loads, such as e.g. this attack.

**International Volleyball Federation rules state that only one-piece net antennae may be used at official tournaments.**

According to the DVV testing body for materials, two-piece antennae with a stable join in the protected part of the pouch are also permitted. **Our two-piece antennae meet these safety standards.**

## Volleyball Antennae without Pockets

- No. 5025**      One-piece volleyball antennae, length 1.80 m, without pockets. £ 13.00 per pair
- No. 5026**      Two-piece volleyball antennae, length 1.80 m, without pockets. £ 16.00 per pair

## Antenna Pockets

- No. 5023**      High frequency **welded pockets** for volleyball antennae with **coated polyester** boundary marker. £ 19.00 per pair
- No. 5053**      **Integrated pockets** with DVV approval, as no. 5023, **but already fitted to net.** £ 20.60 per pair

Improved design: the two pieces meet in the protected part of the pouch and the join is extremely stable.

No. 5021



## Sit Volleyball Net (size: 0.80 × 6.50 m)

- No. 5266**      **Knotless** volleyball tournament net in approx. **3 mm high tenacity polypropylene** with **Kevlar cable** (11.70 m long). Fibreglass-reinforced polyester rods sewn into the sides at each end, **6-point suspension** and 6 tie cords with quick-release fastener.  
Colour: ●      £ 110.00 each



Sit Volleyball Net with printed headband upon request.

## Net Accessories

**No. 535** **Tie cords** for DVV I and II-approved volleyball nets with quick-release fastener, 2 m long (see photo). 4 or 6 cords required per net. These cords can only be used with volleyball nets that have fibreglass polyester rods at the sides.

£ 5.00 each

**No. 537** **Spare tensioner**, black, for tensioning the net (see photo).

£ 2.00 each



No. 537/535

## Spare parts for retrofitting volleyball nets.

**No. 5020** Volleyball **antenna pockets** with **Velcro fastening** for a quick and easy attachment to net.

£ 21.00 per pair

**No. 9082** **Spare cable** in 4 mm dia. galvanised **steel**, length 11.70 m with 2 loops.

£ 14.00 each

**No. 9083** **Spare tensioning cable** in **Kevlar** aramid fibre, length 11.70 m, with 2 loops.

£ 17.00 each

**No. 9084** Surcharge for supplying volleyball nets with 11.70 m long **Kevlar cable** (instead of steel cable).

£ 8.00 each



No. 5020



No. 9082



No. 9083

## Huck solutions to the problem of storing and transporting nets.

**No. 530** **Frame** for rolling volleyball nets.

£ 19.00 each

**No. 540** **Bag** for carrying volleyball nets made of lightweight nylon. Ideal for transporting and storing volleyball nets.

Length: 1.05 m

Diameter: 25 cm

£ 11.00 each



No. 540



No. 530





No. 6001, No. 6021

## Badminton tournament nets conforming to DIN EN 1509

*Dimensions: length 6.02 m, height 0.76 m, mesh size approx. 18 mm, 8 m Kevlar cable, sides reinforced with polyester rods. With extra **strong** tape.*

- No. 6001** Badminton tournament net conforming to DIN EN 1509 in approx. **1.2 mm high tenacity polypropylene**. Mesh size approx. 18 mm.  
Colour: ● £ 40.00 each
- No. 6021** Badminton tournament net conforming to DIN EN 1509 in approx. **1.8 mm high tenacity polypropylene**. Mesh size approx. 18 mm.  
Colour: ● £ 49.00 each



No. 6001, No. 6021

*Badminton nets manufactured to order (including shorter ones) are subject to a surcharge.*

**See page 4.2 for sets of nets!**

**All badminton tournament nets are fitted with a plastic disc at both ends of the net, to prevent the steel or Kevlar cable from accidentally slipping back into the tape. All badminton tournament nets have an extra strong headband (but no belt tensioner).**

## Badminton Tournament Nets

*International dimensions: length 6.02 m, height 0.76 m, mesh size approx. 18 mm, 6.60 m long steel or Kevlar cable. With extra **strong** tape.*

- No. 600** "**Champion**" badminton tournament net in approx. **1.2 mm high tenacity polypropylene**, mesh size approx. 18 mm, with **steel cable**, 6.60 m long, but no polyester rods.  
Colour: ● £ 31.00 each
- No. 601** "**Champion**" badminton tournament net as no. 600, but with **Kevlar cable**, 6.60 m long, no polyester rods.  
Colour: ● £ 36.00 each
- No. 602** "**Perfect**" badminton tournament net in approx. **1.8 mm high tenacity polypropylene**, mesh size approx. 18 mm, with **steel cable**, 6.60 m long, but no polyester rods.  
Colour: ● £ 39.00 each
- No. 603** "**Perfect**" badminton tournament net as no. 602, but with **Kevlar cable**, 6.60 m long, no polyester rods.  
Colour: ● £ 43.00 each

## "Light" badminton tournament net

**NEW**

*International dimensions: length 6.02 m, height 0.76 m, mesh size approx. 20 mm, tensioning rope **8 m long**. With extra **light** tape.*

- No. 604** "**Light**" badminton tournament net made in approx. **1 mm high tenacity polypropylene**, mesh size approx. 20 mm, with 8 m long tensioning rope approx. 4 mm dia., tape all round, but no polyester rods.  
Colour: ● £ 23.50 each

**NEW**



## Sets of Badminton Nets

Our "**Champion**" and "**Perfect**" badminton tournament nets are also available **as part of a set, each consisting of two, three or four nets** without polyester rods **on a long Kevlar cable**.

<b>No. 60002-06</b>	<b>2 nets:</b> No. 600 'Champion', Kevlar cable length: <b>15 m.</b>	£ 75.00 per set
<b>No. 60003-06</b>	<b>3 nets:</b> No. 600 'Champion', Kevlar cable length: <b>23 m.</b>	£ 113.00 per set
<b>No. 60004-06</b>	<b>4 nets:</b> No. 600 'Champion', Kevlar cable length: <b>31 m.</b>	£ 151.00 per set
<b>No. 60202-06</b>	<b>2 nets:</b> No. 602 'Perfect', Kevlar cable length: <b>15 m.</b>	£ 85.00 per set
<b>No. 60203-06</b>	<b>3 nets:</b> No. 602 'Perfect', Kevlar cable length: <b>23 m.</b>	£ 128.00 per set
<b>No. 60204-06</b>	<b>4 nets:</b> No. 602 'Perfect', Kevlar cable length: <b>31 m.</b>	£ 170.00 per set

## Badminton Training Nets

<b>No. 6000</b>	<b>"Champion" long badminton net.</b> Length of the Kevlar cable: length of the net + 0.60 m. Colour: ●	£ 7.00 per metre
<b>No. 6020</b>	<b>"Perfect" long badminton net.</b> Length of the Kevlar cable: length of the net + 0.60 m. Colour: ●	£ 8.00 per metre

**Please note: If Kevlar cables in other lengths are needed, please state this when ordering!**



## Badminton Accessories

- No. 532** **Belt and tensioning device** with ratchet mechanism for badminton and volleyball nets. Tensioning device consisting of 25 mm polyester belts, which can be fitted at either side, and integral ratchet for tensioning. On one side, fixed belt, 90 cm long, with hook and on the other, adjustable belt, also 90 cm long, with hook.  
**To tighten:** lock the tensioning lever of the ratchet mechanism  
**To release:** release the lock in the tensioning lever, open the tensioning lever completely until it reaches a horizontal position and snap the lock into place in the 2 grooves of the belt roller.  
 £ 14.00 each
- No. 533** **Belt tensioner with clamp lock** and 2 hooks consisting of a 25 mm polyester belt, 100 cm long when extended, with large hand loop, 1 clamp lock and 2 hooks.  
 Tensioning: 15 – 60 cm.  
 £ 8.00 each
- No. 608** Extra charge for Kevlar or steel rope **extension from 6.60 m to 8 m.** £ 1.65 each

- No. 2105** **Kevlar tension cable**, approx. 5 mm, for badminton nets.  
 £ 1.00 per metre



No. 2105

## Badminton Training Nets

- No. 607** Badminton net in approx. **1.2 mm high tenacity polypropylene** with nylon tension cord, 6.10 m long, 76 cm high, 20 mm mesh, reinforced all the way around.  
 Colour: ● ● £ 18.00 each

### Surcharge for smaller nets:

per single net  
 nets under 5 m<sup>2</sup> + 100 %  
 nets under 10 m<sup>2</sup> + 35 %  
 nets under 20 m<sup>2</sup> + 20 %

See product information on pages 6.3 and 6.4.

## Shuttlecock Catch Net

- No. 201-020** **Knotless** shuttlecock catch net in approx. **1.8 mm high tenacity polypropylene** with a mesh size of 20 mm and fixed selvage.  
 Colour: ○ ● £ 5.00 per m<sup>2</sup>
- No. 203-020** **Knotless** shuttlecock catch net in approx. **1.5 mm high tenacity polypropylene** with a mesh size of 20 mm and fixed selvage.  
 Colour: ● ● £ 4.00 per m<sup>2</sup>

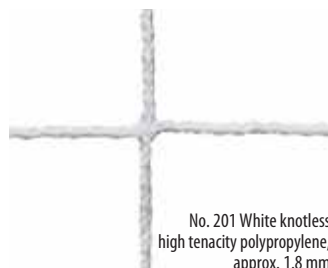

No. 201 White knotless high tenacity polypropylene, approx. 1.8 mm

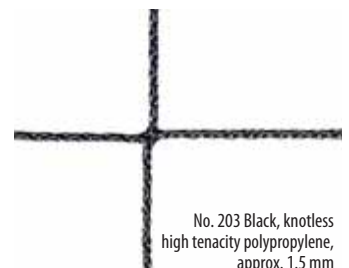

No. 203 Black, knotless high tenacity polypropylene, approx. 1.5 mm



A tennis net of the pioneering generation, No. 8091 Merlin.

## Tennis Nets

The dimensions of our standard nets for doubles courts conform to ITF (International Tennis Federation) and DTB (German Tennis Federation) regulations: 12.72 m × 1.07 m (imperial: 42 ft × 3.5 ft) for installation dimensions that comply with DIN EN 1510.

The headband is made of extremely durable woven polyester and UV-resistant. The nets are fitted with a steel wire cable encased in plastic (13.20 m long) and can be used with all new net posts.

Thanks to our knotless manufacturing technique and square mesh, HUCK tennis nets are aesthetically pleasing as well as practical (e.g. improved visibility).

Our nets can also be supplied for singles courts for a surcharge. All tennis nets can be supplied with an integrated centre strap (see page 5.4).

"Merlin" represents the second generation of knotless square-meshed nets. It follows "Excalibur" and is designed to meet very high quality standards. In addition to standard quality features such as:

- the fixed mesh produced by our knotless manufacturing technique
- high dimensional stability
- optimum visibility with no rows of double mesh (most international tennis tournaments use single-mesh nets),

this net is made of thicker material and therefore heavier so it "falls" better.

**No. 8081** "Excalibur" tennis net in approx. 2.5 mm polyester.  
Colour: ● ● £ 89.00 each

**No. 8091** "Merlin" tennis net in approx. 3.5 mm polyester.  
Colour: ● ● £ 138.00 each

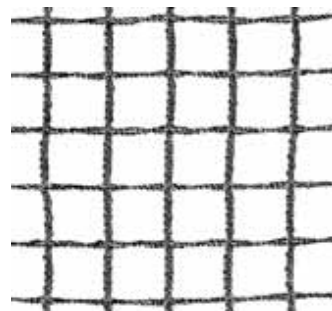

No. 8081-06



No. 8091-06

● = 01 = green ● = 06 = black

**When ordering, please specify which colour you require!**  
e.g. 8081-01 = Tennis net in green.

**Important:** If longer steel cables are needed (especially for older sets of posts), please specify when ordering!

**We do not undertake repairs on tennis nets from other manufacturers!**



No. 8031-06

## Tennis Nets

Tennis nets with no rows of double mesh in regulation ITF and DTB doubles court dimensions: 12.72 m × 1.07 m (imperial: 42 ft × 3.5 ft), for installation dimensions that comply with DIN EN 1510.

**No. 802** **Knotless tennis net in approx. 2.3 mm high tenacity polypropylene** (for leisure use).

Colour: ● £ 72.00 each

**No. 803** **Knotless tennis net in approx. 3 mm high tenacity polypropylene.**

Colour: ● £ 89.00 each

**No. 8031** **Knotless tennis net in 3 mm polypropylene,** all sides taped.

Colour: ● £ 97.00 each

**No. 8041** **Extremely strong tennis net** made to withstand the highest demands featuring our proven **knotless** mesh, in **4 mm high tenacity polypropylene**, and **reinforced surround.**

Colour: ● £ 119.00 each

**No. 900** **Knotted tennis net in 3 mm braided polyethylene.**

Colour: ● £ 72.00 each

**No. 9000** **Knotted tennis net in 3 mm braided polyethylene,** all sides taped.

Colour: ● £ 78.00 each



No. 803 / No. 8031



No. 8041



No. 900 / No. 9000

All tennis nets can be fitted with a 5 mm Kevlar aramid fibre cable for a surcharge.

This avoids the problem of kinks forming in the steel cable when tennis nets are dismantled.



## Tennis Nets

**Tennis nets with rows of double mesh** in regulation ITF and DTB doubles court dimensions: 12.72 m × 1.07 m (imperial: 42 ft × 3.5 ft), for installation dimensions that comply with DIN EN 1510.

- No. 904** Tennis net in approx. **3 mm braided polyethylene** with 5 continuous rows of double mesh (**handwoven**).  
Colour: ● ● £ 138.00 each
- No. 9044** Tennis net in approx. **3 mm braided polyethylene** with 5 continuous rows of double mesh (**handwoven**), and **reinforced surround**.  
Colour: ● ● £ 151.00 each
- No. 904M** Tennis net in approx. **3 mm braided polyethylene** with 5 continuous rows of double mesh (**turned down**).  
Colour: ● £ 133.00 each
- No. 805** **Knotless** tennis net in approx. **3 mm polypropylene**. **Top with double mesh (handwoven)**.  
Colour: ● £ 118.50 each



No. 904



No. 910



No. 9044

**Coated tennis nets** in regulation ITF and DTB doubles court dimensions: 12.72 m × 1.07 m (imperial: 42 ft × 3.5 ft) for installation dimensions that comply with DIN EN 1510.

- No. 910** **Knotless** tennis net in approx. **4 mm coated polyester**. **Netting guaranteed for 3 years**.  
Colour: ● £ 201.00 each

● = 01 = green   ● = 06 = black

**When ordering, please specify which colour you require!**  
(e.g. 904-06)



No. 805-06

## Tennis Accessories

- No. 905** **Centre strap** made of white plastic-coated nylon. £ 4.00 each
- No. 9052** **Centre strap** made of 100% polyester with plastic snap buckle and stainless steel snap hooks. £ 8.00 each
- No. 9053** **Integrated Centre strap** like item 9052 £ 11.00 each
- No. 906** **Polyester net cord** with brass eyelets and lacing cords. Easily fitted by any groundsman. £ 34.00 each
- No. 908** Galvanised, plastic-coated **steel wire cable**, 13.50 m long, with loops. £ 15.00 each
- No. 9085** As No. 908, but 13.20 m long. £ 15.00 each
- No. 9081** **Tension cable** in approx. 5 mm **Kevlar aramid fibre**, 13.50 m long with loops. £ 18.00 each
- No. 9086** As No. 9081, but 13.20 m long. £ 18.00 each
- No. 907** **Galvanised tensioning screw** for item 905. £ 9.00 each
- No. 909** **Ground anchor pin** (galvanised), for tennis net centre strap. £ 7.00 each
- No. 9091** **Aluminium ground sleeve** for any type of centre strap. £ 21.00 each



No. 9053



No. 9052 + No. 9091



No. 906

## Ground Anchor System

- No. 2109** This **ground anchor** consists of a 3 mm steel wire cable, 40 cm long, and loop. It is knocked into the ground using a round bar, 45 cm long, and then removed. When the cable loop is pulled, the anchor turns diagonally in the ground becoming securely anchored. **Resistance: approx. 100 kg** £ 28.00 each
- No. 21091** Ground anchor like item 2109 but with **stainless steel cable**. £ 34.00 each

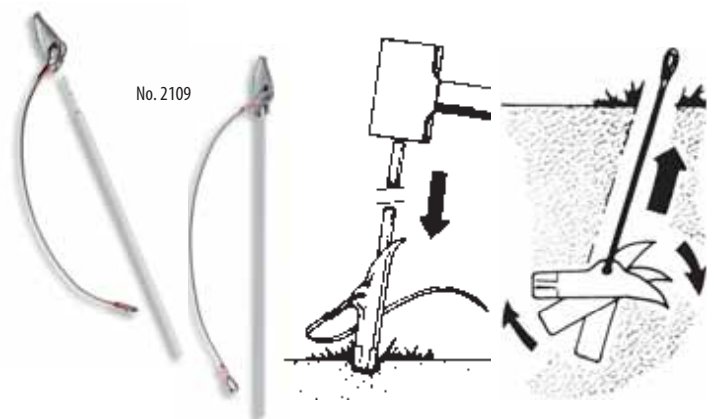

## Tennis Court Drag Nets

- No. 913** **Tennis court drag net** in tried and tested plastic-coated polyester with a mesh size of just  $2 \times 2$  cm. The small mesh size increases the efficiency of court maintenance without the need for a two-ply mesh. **Net size:** approx. 2 m wide, 1.50 m long. **Complete with wooden bar and pull cord.**  
Colour: ● £ 91.80 each
- No. 914** **Spare net** for item 913.  
Colour: ● £ 41.00 each
- No. 917** **Tennis court drag net** in coated 3 mm polyester with two-ply mesh. Mesh size:  $4 \text{ cm} \times 4 \text{ cm}$ . **Net size:** approx. 2 m wide, 1.50 m long. Complete with wooden bar and pull cord.  
Colour: ● £ 84.50 each
- No. 917A** **Tennis court drag net** as no. 917 but 4 mm polyester. **Net size:** approx. 2 m wide, 1.10 m long.  
Colour: ● £ 84.50 each
- No. 918** **Spare net** for item 917.  
Colour: ● £ 39.50 each
- No. 916** **Spare wooden bar**, for item 913 + 917, supplied in two parts with screws.  
£ 35.00 each

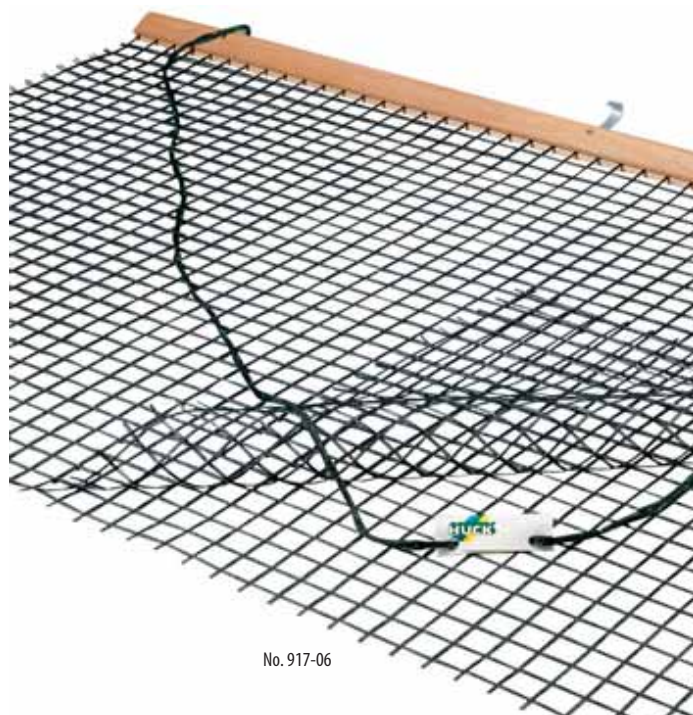

No. 917-06



Pull cords with galvanised fasteners

## Pull Cords

- No. 9093** **Pull cords** for tennis court drag nets in approx. 10 mm soft braided plastic. **Length 3.50 m.** Galvanised fasteners on both ends.  
Colour: ● £ 4.00 each



No. 915-06, 916

## Drag Nets on Rolls

- No. 924R** **Coated polyester material**, approx 4 mm for tennis drag nets.  
**Mesh size:**  $4 \times 4$  cm  
**Roll:** approx.  $1.15 \times 130 \text{ m} = 149.50 \text{ m}^2$   
**Weight per roll:** approx. 69.90 kg  
**Weight per  $\text{m}^2$ :** approx. 480 g  
Colour: ● £ 1,892.80 per roll
- No. 926R** **Coated polyester material**, approx. 3 mm for tennis drag nets  
**Mesh size:**  $4 \times 4$  cm  
**Roll:** approx.  $1.50 \times 50 \text{ m} = 75 \text{ m}^2$   
**Weight per roll:** approx. 34.50 kg  
**Weight per  $\text{m}^2$ :** approx. 460 g  
Colour: ● £ 562.50 per roll
- No. 915R** **Close-meshed coated polyester netting** for tennis court drag nets.  
**Mesh:**  $2 \times 2$  cm  
**Rolls:** approx.  $2 \times 25 \text{ m} = 50 \text{ m}^2$   
**Weight per roll:** 40 kg  
**Weight per  $\text{m}^2$ :** 800 g  
Colour: ● £ 575.00 per roll

● = 01 = green   ● = 06 = black

When ordering, please specify which colour you require! (e.g. 924-06)



## Junior Tennis Nets with Posts

for a set of posts measuring  $0.70 \times 6$  m:

- No. 940** **Set of freestanding posts.** Tubular steel posts, galvanised in gold, that fit together. Diameter approx. 25 mm.  
Size:  $0.70 \times 6$  m. £ 98.00 per set
- No. 934** **Junior tennis net** in approx. 1.5 mm high tenacity polypropylene, mesh size 30 mm. Tarpaulin pouches at the sides, elastic net cord at the top **for rapid and optimal adjustment of the net tension.**  
Size: approx.  $0.70 \times 6$  m.  
Colour: ● £ 37.00 each
- No. 830** **Junior Tennis net** in rotproof polyethylene.  
Size: approx.  $0.70 \times 6$  m.  
Colour: ● Green with white edging. £ 12.00 each



No. 940 + No. 934

for a set of posts measuring  $0.70 \times 3$  m:

- No. 941** **Set of posts** like item 940 but  $0.70 \times 3$  m. £ 85.00 per set
- No. 935** **Junior Tennis net**, like item 934 but  $0.70 \times 3$  m.  
Colour: ● £ 29.00 each
- No. 831** **Junior Tennis net**, like item 830 but  $0.70 \times 3$  m.  
Colour: ● Green with white edging. £ 10.00 each
- No. 636** **Net ballast bag** made of small woven HDPE bands. Ballast not included. £ 5.00 each
- No. 933** **Junior Tennis net**, in approx. 2.3 mm high tenacity polypropylene.  
Size:  $0.80 \text{ m} \times 6$  m.  
Colour: ● £ 47.00 each



No. 941 + No. 831



**For beach and street tennis equipment, see Beach & Fun on pages 9.9 and 9.10.**



No. 220-01

## Standard Dividing Nets for indoor and outdoor tennis courts

### Additional features included in the price:

a) Steel wire cable, approx. 4 mm thick and 38 mm long, with a turnbuckle at each end.

b) Lead cord weighting, 200 g per m, encased in PES webbing and attached to the net.

c) Split nylon rings, 3 per m, attached to net.

**No. 220** **Dividing net** in approx. 2.3 mm high tenacity polypropylene, mesh size 4.5 cm. Dimensions: approx. **40 × 2.50 m**.  
Colour: ● ● ○ £ 388.00 per panel

**No. 221** **Dividing net**, like item 220 but **40 × 3 m**.  
Colour: ● ● ○ £ 445.00 per panel

We recommend **dark green** (colour 015) and **white** (colour 02) for indoor courts and **green** (colour 01) for outdoors.

**No. 2205** **Freestanding telescopic support posts** for standard dividing nets. Fully adjustable between 2 and 3 m.  
£ 28.00 each

In order to protect the lower part of the net, items 2201 and 2211 have a strip of plastic-coated polyester, approx. 15 cm wide, along the bottom.

These nets do not have lead cord weighting.

**No. 2201** **Dividing net** in approx. 2.3 mm high tenacity polypropylene, mesh size 4.5 cm. Dimensions: approx. **40 × 2.50 m**. With a **strip of plastic-coated polyester, approx. 15 cm wide**, along the bottom.  
Colour: ● ○ £ 388.00 per panel

**No. 2211** **Dividing net** like item 2201 but **40 × 3 m**.  
Colour: ● ○ £ 445.00 per panel

● = 01 = green

● = 015 = dark green

○ = 02 = white

When ordering, please specify which colour you require! (e.g. 220-015)



## Standard Dividing Nets with flame retardant finish

### Additional equipment included in the price:

a) Steel wire cable, approx 4 mm thick and 38 m long, with a turnbuckle at each end.

b) Lead cord weighting, 200g per m, encased in PES webbing and attached to the net.

c) Split nylon rings, 3 per m, attached to the net.

<p><b>No. 220F</b>     <b>Dividing net in 2.3 mm high tenacity polypropylene, in flame retardant finish.</b> Mesh size approx 4.5 cm. Dimensions: approx. 40 × 2.50 m Colour: ● ○     £ 428.00 each</p>	<p><b>No. 221F</b>     <b>Dividing net like item 220F, but 40 × 3 m.</b> Colour: ● ○     £ 493.00 each</p>
---	--

## Dividing Nets in custom sizes

<p><b>No. 200-045</b>     Safety net made of approx. <b>2.3 mm high tenacity polypropylene</b>, mesh size approx. 45 mm. Colour: ● ● ○     £ 4.00 per m<sup>2</sup></p>	<p><b>No. 200F045</b>     Safety net made of approx. <b>2.3 mm high tenacity polypropylene, flame retardant finish</b>, mesh size approx. 45 mm. Colour: ● ○     £ 4.00 per m<sup>2</sup></p>
---	---

### For hanging and tensioning the nets, we recommend:

<p><b>No. 2102</b>     Steel wire cable, zinc-coated, 4 mm thick. £ 1.00 per metre</p>	<p><b>No. 2111</b>     Lead cord encased in webbing fixed to net, 200g per metre. £ 4.00 per metre</p>
<p><b>No. 2122</b>     Split nylon rings, ø 9 mm, length 53 mm, width 30 mm, inner length 35 mm, black, 3 rings attached to net per metre. £ 3.00 per metre</p>	

### Surcharge for smaller nets: per single net

For each net below 5 m<sup>2</sup> + 100 %  
For each net below 10 m<sup>2</sup> + 35 %  
For each net below 20 m<sup>2</sup> + 20 %





## Tennis Court Surrounds and Indoor Panelling

Our surrounds and indoor panelling are manufactured from breathable polyethylene and therefore do not damage fencing. Ideal for advertising.

Every surround is reinforced all round and comes with metal eyelets at a distance of ca. 50 cm. Snap hooks come with each surround.

**No. 700** **Standard tennis court surround, 200 g/m<sup>2</sup>**, 12 m long, 2 m high, breathable. 56 snap hooks supplied loose with every surround.

Colour: ● ● £ 88.00 each  
 Colour: ● ● ● £ 99.00 each

**No. 712** **Tennis court surround** like item 700, 2 m high,.

Colour: ● ● ● £ 8.00 per metre  
 Colour: ● ● ● ● £ 8.75 per metre

**No. 710** **Tennis court surrounds/indoor panelling, 200 g/m<sup>2</sup>**, in any dimensions made of Polyethylene fabric.  
 Optional: a hollow seam, approx. 5 cm wide, along the bottom to hold a lead cord (see page 6.6).

Colour: ● ● ○ £ 6.50 per m<sup>2</sup>  
 Colour: ● ● £ 6.00 per m<sup>2</sup>  
 Colour: ● ● ● ● £ 6.20 per m<sup>2</sup>

**No. 766** **Tennis court surrounds/indoor panelling, 230 g/m<sup>2</sup>**, **opaque fabric** in any dimensions made of monofilament Polyethylene fabric/tape.

Colour: ● £ 7.00 per m<sup>2</sup>

**NEW**

**No. 776** **Tennis court surrounds/indoor panelling, 320 g per m<sup>2</sup>, in a particularly opaque, flame-retardant fabric** in Polyethylene monofilament/tape, in any dimensions.

Colour: ● ● ● ● £ 9.00 per m<sup>2</sup>

(Cream colour does NOT have flame retardant finish)



No. 710



No. 776

● = 010 = green      ● = 04 = blue      ● = 86 = cream  
 ● = 015 = dark green      ● = 07 = red      ● = 66 = silver  
 ○ = 02 = white      ● = 03 = orange      ● = 76 = terracotta

When ordering, please specify which colour you require! (e.g. 700-015)

## Snap hooks

**No. 21210** Galvanised **snap hooks** for suspending tennis court surrounds.  
 £ 9.00 per bag of 56

We recommend our galvanised steel wire cables with cable eyes and a turnbuckle at both ends for suspending and tensioning the panelling.

**For other weighting and suspension accessories, see pages 6.5 and 6.6.**

### Surcharges for smaller surrounds for item 710, 766 and item 776:

surrounds below 5 m<sup>2</sup> + 100 %  
 surrounds below 10 m<sup>2</sup> + 35 %  
 surrounds below 20 m<sup>2</sup> + 20 %

## Printed Advertising on HUCK Tennis Court Surrounds using special weatherproof dye.

The lettering is airbrushed.

Before each job, you will receive a proof to scale, showing you how your printing will look.

Standard typeface: Helvetica characters

No. 7610:	1 line, Helvetica	Price on request
No. 7620:	2 line, Helvetica	Price on request
No. 7630:	3 line, Helvetica	Price on request

**Wilhelm Bungert**  
Sanitär – Heizung  
Gottfried-von-Cramm-Straße 12 • Tel. 23 45 67

Surround with 3-line advertisement

## Individual designs



Tennis court surround individually designed to meet your requirements

For the artwork, we require a vectorised file (EPS format), where possible.

Files can be e-mailed directly to: [sports@hucknetting.co.uk](mailto:sports@hucknetting.co.uk)

The special ink used is **weather-resistant**, but cannot be guaranteed against wear and tear.

## Product Information

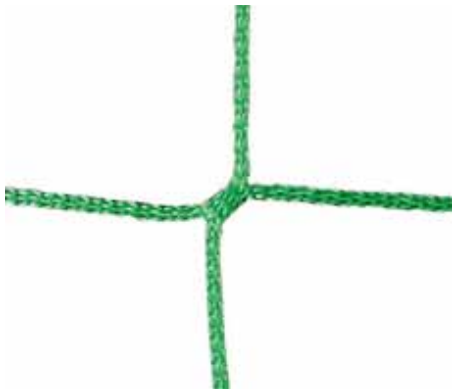

**No. 200** Green, knotless  
high tenacity polypropylene, approx. 2.3 mm.



**No. 200** White, knotless  
high tenacity polypropylene, approx. 2.3 mm.

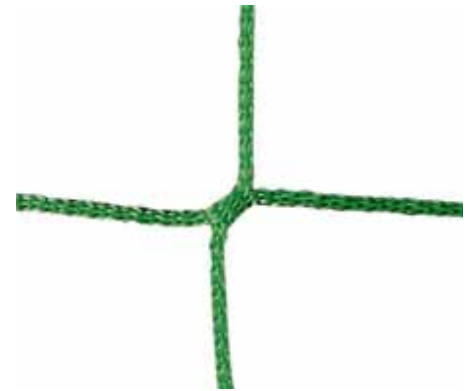

**No. 200** Dark green, knotless  
high tenacity polypropylene, approx. 2.3 mm.



**No. 200** Black, knotless  
high tenacity polypropylene, approx. 2.3 mm.



**No. 201** Black, knotless  
high tenacity polypropylene, approx. 1.8 mm.



**No. 201** White, knotless  
high tenacity polypropylene, approx. 1.8 mm.

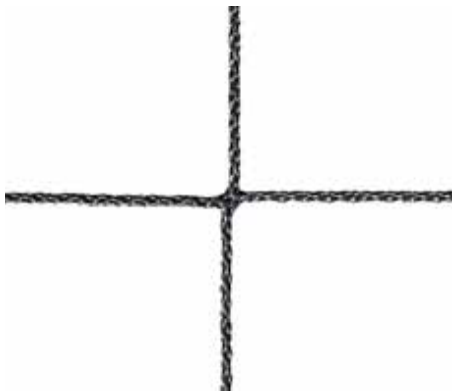

**No. 203** Black, knotless  
high tenacity polypropylene, approx. 1.5 mm.

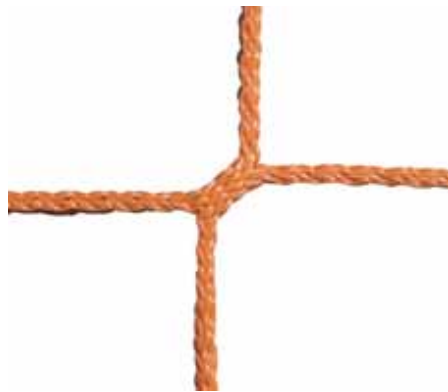

**No. 205** Orange, knotless  
high tenacity polypropylene, approx. 2.8 mm.



**No. 207** Violet, knotless  
high tenacity polypropylene, approx. 3.5 mm.

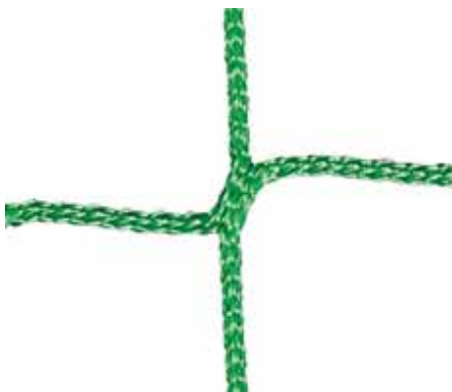

**No. 209** Green, knotless  
high tenacity polypropylene, approx. 3 mm.



**No. 209** White, knotless  
high tenacity polypropylene, approx. 3 mm.



**No. 209** Blue, knotless  
high tenacity polypropylene, approx. 3 mm.

## Product Information



**No. 209** Black, knotless  
high tenacity polypropylene, approx. 3 mm.

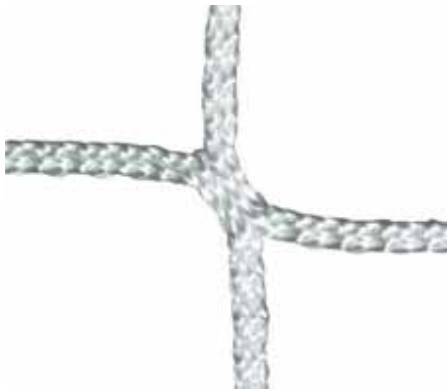

**No. 210** White, knotless  
high polyester, approx. 4 mm.



**No. 212** Green, knotless  
high tenacity polypropylene, approx. 5 mm.



**No. 212** White, knotless  
high tenacity polypropylene, approx. 5 mm.



**No. 212** Orange, knotless  
high tenacity polypropylene, approx. 5 mm.



**No. 212** Blue, knotless  
high tenacity polypropylene, approx. 5 mm.



**No. 212** Black, knotless  
high tenacity polypropylene, approx. 5 mm.



**No. 212** Red, knotless  
high tenacity polypropylene, approx. 5 mm.



**No. 213** White, knotless  
high tenacity polypropylene, approx. 6 mm.



**No. 215** Green, knotless  
high tenacity polypropylene, approx. 4 mm.



**No. 215** Yellow, knotless  
high tenacity polypropylene, approx. 4 mm.

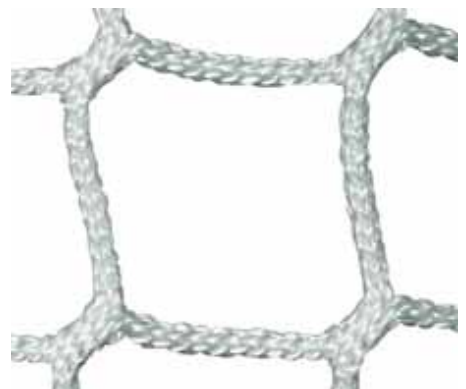

**No. 216** White, knotless  
polyester, approx. 3 mm.



## Material diameter of 1.5 – 2.8 mm

Art.-No.	Description	Diameter approx. mm	Mesh size mm	Colour	£/m <sup>2</sup>
1203-010	PP high tenacity, knotless (*)	1.5 diamond mesh	10	●	£ 5.00
203-020	PP high tenacity, knotless	1.5	20	●	£ 4.00
203-028	PP high tenacity, knotless	1.5	28	●	£ 3.00
203-030	PP high tenacity, knotless	1.5	30	○ ●	£ 3.00
203-050	PP high tenacity, knotless	1.5	50	●	£ 2.00
203-060	PP high tenacity, knotless	1.5	60	●	£ 2.00
203-100	PP high tenacity, knotless	1.5	100	●	£ 1.00
201-020	PP high tenacity, knotless	1.8	20	○ ●	£ 5.00
201-025	PP high tenacity, knotless	1.8	25	● ●	£ 4.00
201-030	PP high tenacity, knotless	1.8	30	●	£ 7.00
200-020	PP high tenacity, knotless	2.3	20	● ● ○ ● ●	£ 7.00
200-025	PP high tenacity, knotless	2.3	25	●	£ 6.00
200-030	PP high tenacity, knotless	2.3	30	○ ●	£ 5.00
200-035	PP high tenacity, knotless	2.3	35	○ ●	£ 4.00
200-045	PP high tenacity, knotless	2.3	45	● ● ○ ● ●	£ 4.00
200-100	PP high tenacity, knotless	2.3	100	● ○ ●	£ 2.00
200-120	PP high tenacity, knotless	2.3	120	● ● ○ ●	£ 1.00
205-100	PP high tenacity, knotless	2.8	100	●	£ 2.00
205-120	PP high tenacity, knotless	2.8	120	●	£ 2.00

## Material diameter of 3 – 3.5 mm

209-030	PP high tenacity, knotless (NEW)	3	30	●	£ 5.00
209-045	PP high tenacity, knotless	3	45	● ○ ● ● ● ● ● ●	£ 4.00
209-100	PP high tenacity, knotless	3	100	● ○ ● ●	£ 2.00
209-120	PP high tenacity, knotless	3	120	● ○ ● ●	£ 2.00
216-035	Polyester, knotless	3	35	○	£ 8.00
216-045	Polyester, knotless	3	45	○	£ 7.00
216-100	Polyester, knotless	3	100	○	£ 3.00
216-130	Polyester, knotless	3	130	○	£ 3.00
207-045	PP high tenacity, knotless	3.5	45	● ● (**)	£ 6.00
207-100	PP high tenacity, knotless	3.5	100	● ● (**)	£ 3.00
207-120	PP high tenacity, knotless	3.5	120	● ● (**)	£ 2.00

Surcharge for smaller quantities per net: under 5 m<sup>2</sup> + 100 % | under 10 m<sup>2</sup> + 35 % | under 20 m<sup>2</sup> + 20 %

**Polypropylene is recommended for outdoor use.**

All nets have a **fixed selvage** of approx. 5 – 7 mm

**included in the price per square metre (\*)**.

(\*) except item 1203-010 in black

(\*) Item 1203-010 in black = diagonal mesh design, cut lengths only.

**When ordering loose hanging nets, the required length must be increased by the following amounts based on the mesh size:**

**a) Mesh of up to 45 mm + 20 %   b) Mesh of 60 mm bis 100 mm + 15 %   c) Mesh of 110 mm bis 150 mm + 10 %.**





## Material diameter of 4 – 4.5 mm

Art.-No.	Description	Diameter approx. mm	Mesh size mm	Colour	£/m <sup>2</sup>
210-035	Polyester, knotless	4	35	○	£ 10.00
210-045	Polyester, knotless	4	45	○	£ 7.00
210-100	Polyester, knotless	4	100	○	£ 4.00
210-120	Polyester, knotless	4	120	○	£ 3.00
215-030	PP high tenacity, knotless	4	30	● ●	£ 9.00
215-045	PP high tenacity, knotless	4	45	● ○ ● ● ● ●	£ 7.00
215-100	PP high tenacity, knotless	4	100	● ○ ● ● ● ●	£ 4.00
215-120	PP high tenacity, knotless	4	120	● ○ ● ● ● ●	£ 3.00
215-120	PP high tenacity, knotless	4	120	● ○ ● ● ● ● ● ●	£ 3.00
214-045	PP high tenacity, knotless	4.2	45	●	£ 7.00
211-045	Polyester, knotless	4.5	45	●	£ 9.00

## Material diameter of 5 – 6 mm

212-030	PP high tenacity, knotless (NEW)	5	30	●	£ 9.50
212-045	PP high tenacity, knotless	5	45	● ○ ● ● ● ●	£ 7.00
212-060	PP high tenacity, knotless	5	60	● ● ● ●	£ 7.00
212-070	PP high tenacity, knotless	5	70	●	£ 6.00
212-100	PP high tenacity, knotless	5	100	● ○ ● ● ● ● ● ●	£ 4.00
212-120	PP high tenacity, knotless	5	120	● ○	£ 3.00
213-100	PP high tenacity, knotless	6	100	○	£ 10.00

Item 209-045 gives you 4 colours in one net.

If nets made to special requirements have a square mesh, it is **technically impossible to supply all net sizes without a seam**.

All nets are manufactured with diagonal mesh to the greatest possible width and then converted to square mesh.

**The resulting seams cannot be avoided for technical reasons and do not reduce the quality of the net.**

## Colour Index

● = 01 = green	● = 07 = red	○ = 12 = green/white
● = 015 = dark green	● = 08 = hemp coloured	○ = 42 = blue/white
○ = 02 = white	● = 09 = violet	○ = 72 = red/white
● = 03 = orange	● = 4F (in one net)	○ = 45 = blue/yellow
● = 04 = blue		○ = 62 = black/white
● = 05 = yellow		○ = 65 = black/yellow
● = 06 = black		○ = 67 = black/red

**When ordering, please specify which colour you require.**

(e.g. 212-100-07 = PP high tenacity, approx. 5 mm, mesh 100 mm, red)

No. 209-045 high tenacity polypropylene, knotless, approx. 3 mm.  
Colour: 4F ● ● ● ● £ 5.00 per m<sup>2</sup>



A net that suits all colour tastes!  
Item 209-045 gives you 4 colours (red, blue, yellow and green) in one net.



## Standard Stop Nets

Safety and stop nets supplied by the metre in any length. Width: 5 m.

- No. 2140-120** High tenacity polypropylene, approx. 3 mm, mesh size 12 cm.  
 Colour: ● £ 2.00 per m<sup>2</sup>
- No. 2142-120** High tenacity polypropylene, approx. 4 mm, mesh size 12 cm.  
 Colour: ● £ 3.00 per m<sup>2</sup>

**Surcharge for smaller quantities:**  
per net

- nets under 5 m<sup>2</sup> + 100 %  
 nets under 10 m<sup>2</sup> + 35 %  
 nets under 20 m<sup>2</sup> + 20 %

## Net Edge Cords

a) Incorporated in the net

- No. 2130** Polyethylene rope, 6 mm  
 Colour: ● ● ● £ 0.48 per metre
- No. 2131** Nylon rope, 5 mm  
 Colour: ○ £ 0.48 per metre
- No. 2132** Nylon rope, 8 mm  
 Colour: ○ £ 0.86 per metre
- No. 2136** Nylon rope, 12 mm  
 Colour: ○ £ 1.36 per metre

b) Supplied loose

- No. 21300** Polyethylene rope, 6 mm  
 Colour: ● ● ● £ 0.36 per metre
- No. 21310** Nylon cord, 5 mm  
 Colour: ○ £ 0.36 per metre
- No. 21320** Nylon rope, 8 mm  
 Colour: ○ £ 0.60 per metre
- No. 21360** Nylon rope, 12 mm  
 Colour: ○ £ 1.10 per metre

All nets have a fixed selvage of approx. 5 – 7 mm included in the price per square metre.

See pages 6.1 and 6.2 for details of our safety and stop net materials and colours.

● = 01 = green   ○ = 02 = white   ● = 03 = orange   ● = 06 = black

When ordering, please specify which colour you require. (e.g. 2130-06 = PE rope, approx. 6 mm, black)



## All safety and stop nets can be supplied with the following features:

For tensioning and suspension of our nets, we recommend our galvanised steel wire cables with cable eyes and a turnbuckle at each end:

<b>No. 2100</b>	Galvanised steel wire cable, 6 mm.	£ 1.00 per metre
<b>No. 2101</b>	Plus cable eyes and turnbuckle at both ends of the 6 mm cable.	£ 19.00 extra charge
<b>No. 2102</b>	Galvanised steel wire cable, 4 mm.	£ 1.00 per meter
<b>No. 2103</b>	Plus cable eyes and turnbuckle at both ends of the 4 mm cable.	£ 15.00 extra charge
<b>No. 2097</b>	Steel wire cable, <b>PVC-coated</b> , 5/7 mm thick	£ 1.00 per metre
<b>No. 2099</b>	Steel wire cable, <b>PVC-coated</b> , 4/5 mm thick	£ 1.40 per metre
<b>No. 2098</b>	Steel wire cable, <b>PVC-coated</b> , 3/4 mm thick	£ 1.15 per metre

For weighting our nets, a lead cord encased in webbing and attached to the net:

<b>No. 2110</b>	Weight 400 g per metre.	£ 5.00 per metre
<b>No. 2111</b>	Weight 200 g per metre.	£ 4.00 per metre
<b>No. 2112</b>	Lead cord weighting, 200 g per metre, attached to the net without webbing.	£ 2.00 per metre

For suspending nets so that they move freely on the steel wire cable:

<b>No. 2122</b>	Split nylon rings, 9 mm in diameter, 53 mm long, 30 mm wide, inside length 35 mm, black, 3 rings attached to the net per metre.	£ 3.00 per metre
<b>No. 2123</b>	Split nylon rings, loose.	£ 0.60 each

For additional protection and for securing nets to existing borders or straps:

<b>No. 2116</b>	Net surround made of polyester webbing, 100 mm wide. (50 mm wide when folded back) Colour: ○	£ 4.00 per metre
-----------------	---	------------------



No. 2116-02

## Universal Barrier Fencing

**Quick and economical to erect and easy to transport**, this barrier fencing is ideal for marking out boundaries at sports events.

It is made of **breathable lightweight material**, requires **very little space for storage and transport** and is easily moved. No posts necessary.

**No. 7010-01** **Barrier fence** made of green UV-resistant polyethylene. The posts are made of flexible fibreglass-reinforced polyester, 9 mm in diameter and **woven into the material** so they cannot be lost.  
£ 65.00 each complete

Length of fence 20 m  
Fence height (fabric) 80 cm  
Length of pole 1.10 m  
Distance between poles 1.80 m  
Total weight 3.30 kg  
Complete with 4 ground anchors and tension cords for securing the corners.



Packaged in sales box



No. 7010-01



## Indoor Football Stop Nets

When using conventional halls and indoor tennis courts **for indoor football and other fun sports, stop nets are needed to protect spectators and facilities from stray balls.**

The photo at the top of the page shows safety nets 212-100-01 and 200-100-02 being used to protect the sides and roof of a hall respectively.

- No. 212-100** Safety net made of approx. **5 mm high tenacity polypropylene**, mesh size 100 mm.  
Colour: ● ● ● £ 4.00 per m<sup>2</sup>
- No. 200-100** Safety net made of approx. **2.3 mm high tenacity polypropylene**, mesh size 100 mm.  
Colour: ○ ● £ 2.00 per m<sup>2</sup>
- No. 200-120** Safety net made of approx. **2.3 mm high tenacity polypropylene**, mesh size 120 mm.  
Colour: ● ● ○ ● £ 1.00 per m<sup>2</sup>

### Surcharge for smaller quantities:

per net

nets under 5 m<sup>2</sup> + 100 %

nets under 10 m<sup>2</sup> + 35 %

nets under 20 m<sup>2</sup> + 20 %

### For additional protection and for securing nets to existing borders or straps:

- No. 2116** Net surround made of polyester webbing, 100 mm wide. (50 mm wide when folded back).  
Colour: ○ £ 4.00 per metre



See page 9.13 for nets for small outdoor playing areas.

See pages 6.3 and 6.4 for other materials and colours.



No. 200F045-02 + No. 7710-02

## Partition Curtains for Gymnasiums

The lower section of net can be replaced by breathable fabric to make them more opaque.

- No. 200-045** Safety net in approx. **2.3 mm high tenacity polypropylene**. Mesh size 45 mm.  
Colour: ● ● ○ ● £ 4.00 per m<sup>2</sup>
- No. 720A** Breathable plastic tarpaulin in **double-ribbed polyethylene fabric**, approx. **200 g/m<sup>2</sup>**, reinforced with tape all around.  
Colour: ● ● ○ ● ● £ 5.00 per m<sup>2</sup>
- No. 7222** Tarpaulin 720A **attached/sewn** on to safety net 200-045. £ 5.00 per meter

As these combinations of netting and tarpaulin have to be manufactured individually for each sports hall, please enquire about an entire solution **in advance**.

The nets/tarpaulins are not the same size as the area to be covered and the actual size you require must be calculated first.

## Colour Index

- = 01 = green      ○ = 02 = white      ● = 06 = black  
● = 015 = dark green      ● = 04 = blue      ● = 08 = hemp coloured

**When ordering, please specify which colour you require.**  
(e.g. 212-100-07 = PP high tenacity, approx. 5 mm, mesh 100 mm, red)

Prices excluding VAT

## ... with flame-retardant properties

The nets and sheets have been tested and meet the requirements of DIN 4102 (highly fire-resistant material).

- No. 200F045** Flame-retardant safety net in approx. **2.3 mm high tenacity polypropylene**. Mesh size approx. 45 mm.  
Colour ● ○ ● ● £ 4.00 per m<sup>2</sup>
- No. 7710** Breathable plastic tarpaulin in **high tenacity polypropylene**, approx. **510 g/m<sup>2</sup>** in tightly woven, flame-retardant fabric, and selvedge all the way round.  
Colour: ● ○ ● £ 12.30 per m<sup>2</sup>
- No. 775** Breathable plastic tarpaulin in **high tenacity polypropylene**, approx. **320 g/m<sup>2</sup>**, flame-retardant fabric, and selvedge all the way round.  
Colour: ● ● £ 8.00 per m<sup>2</sup>
- No. 7222** Tarpaulin 7710/775 **attached/sewn** on to safety net 200F045. £ 5.00 per meter

**Surcharge for smaller quantities:**  
per net

nets/tarpaulins under 5 m<sup>2</sup> + 100 %  
nets/tarpaulins under 10 m<sup>2</sup> + 35 %  
nets/tarpaulins under 20 m<sup>2</sup> + 20 %





## Flame-retardant safety nets

These knotless, multi-filament polypropylene nettings in different colours and with **flame-retardant** properties are an important new development in that respect.

These safety nets can also be used outdoors without losing their flame-retardant properties.

**The nets have been tested and meet the requirements of DIN 4102 (highly fire-resistant material).**

No.	Diameter approx. mm	Mesh size approx. mm	Colour	£/m <sup>2</sup>
203F050	1,5	50	●	£ 2.15
200F025	2,3	25	● ○	£ 8.00
200F045	2,3	45	● ○ ● ●	£ 4.00
209F045	3	45	● ○ ● ●	£ 6.00
212F045	5	45	● ○ ●	£ 9.00
212F060	5	60	●	£ 8.00
212F100	5	100	● ○	£ 5.00

## Colour Index

- = 01 = green      ● = 04 = blue      ● = 07 = red
- = 015 = dark green      ● = 05 = yellow      ● = 08 = hemp coloured
- = 02 = white      ● = 06 = black      ●●● = 4F (in one net)

**When ordering, please specify which colour you require.**

e.g. 212F100-01 = PP high tenacity, approx. 5 mm, mesh 100 mm, green

Prices excluding VAT

Materialprüfanstalt für das Bauwesen

**Allgemeines bauaufsichtliches Prüfzeugnis**

Prüfzeugnisnummer: P-ND504-851

Gegenstand: Schutz- und Stoppsnetze aus Polypropylen gemäß Bauregelleiste A Teil 2 - Ausgabe 2011/1 - Lfd. Nr. 2.10.2 als schwerentflammbarer Baustoff (Baustoffklasse B1) nach DIN 4102-1: 1998-05.

Antragsteller: Manfred Huck GmbH  
Netz- und Seilfabrik  
Assliner Straße 13-15  
35614 Asslar-Berghausen

Ausstellungsdatum: 14. Oktober 2011  
Geltungsdauer bis: 31. Januar 2016

Aufgrund dieses allgemeinen bauaufsichtlichen Prüfzeugnisses ist der oben genannte Gegenstand in Sinne der Landesbauordnungen verwendbar.<sup>1</sup>

Dieses allgemeine bauaufsichtliche Prüfzeugnis umfasst 5 Seiten.  
Auftragsnummer: 113741

<sup>1</sup> Dieses allgemeine bauaufsichtliche Prüfzeugnis ersetzt das allgemeine bauaufsichtliche Prüfzeugnis Nr. P-ND504-851 vom 18. Mai 2011. Dem Gegenstand ist erstmals am 18. Mai 2011 eine Prüfzeugnisnummer zugewiesen worden.

Beauftragter: DIN 036-erg. Baustoff  
Dachstuhl: 05 113 742 - 22 40  
E-Mail: kurtstroff@mpa-bau.de

Neuburger Straße 2  
D 30627 Hannover

Telefon: +49 511 362 3170  
Telefax: +49 511 362 4021

Niedersachsen  
Landesbauamt

**Surcharge for smaller quantities:**  
per net

- net under 5 m<sup>2</sup> + 100 %
- net under 10 m<sup>2</sup> + 35 %
- net under 20 m<sup>2</sup> + 20 %



No. 226-02

## Basketball Nets

Competition nets conforming to DIN EN 1270  
in regulation dimensions: 50 cm long (40 cm when fitted).

**Our competition nets were developed in cooperation with the Technical Standards Committee for Sports and Leisure Equipment.**

The net is designed to reduce basketball velocity, thereby ensuring scoring visibility.

- No. 224**      **Basketball net** in approx. **4 mm** braided nylon conforming to DIN EN 1270.  
Colour: ○      £ 4.00 each
- No. 225**      **Basketball net** in approx. **6 mm** braided nylon conforming to DIN EN 1270.  
Colour: ○      £ 5.00 each
- No. 226**      **Anti-whip basketball net** in approx. **6 mm** braided polyester. The suspension loops have a certain rigidity which prevents the net whipping back.  
Colour: ○      £ 6.00 each



No. 225-02

*Recreational and practice nets for street basketball or games in the garden.*

**Our recreational and practice nets are a lighter version of our competition nets.** We recommend these nets for outdoor games.

- No. 222**      **Basketball net** in approx. **3 mm polyethylene cord**.  
Colour: ○      £ 3.00 each
- No. 223**      **Basketball net** in approx. **3 mm braided nylon**.  
Colour: ○ ●      £ 2.00 each  
(while stocks last)
- No. 227**      **Three-colour basketball net** in approx. **4 mm braided polypropylene**.  
three-coloured: ●●●      £ 4.00 each
- No. 4677-2**      **Basketball net, resistant to cuts and tears,**  
in **5 mm Hercules rope**.  
Colour: ●      £ 49.00 each



No. 227



No. 4677-2





The Huck ice hockey goal nets used at the 2004 World Championships in the Czech Republic



No. 1471-02

## Ice Hockey Goal Nets

Approved by the IIHF

- No. 147** Goal net in approx. **4 mm polyester, 35 mm mesh (diamond)**, width 1.93 m, height 1.22 m, top depth 0.50 m, bottom depth 1 m, with additional 0.45 m arcs on each side. International design.  
Colour: ○ £ 165.00 per pair
- No. 1471** Goal net in approx. **4.2 mm polyester, 30 mm mesh (square)**, width 1.93 m, height 1.22 m, top depth 0.50 m, bottom depth 1 m, **with incorporated roof**.  
Colour: ○ £ 175.00 per pair

- = 01 = green                      ● = 06 = black  
○ = 02 = white                     ● = 3F = three-coloured

**When ordering, please specify which colour you require!**  
(e.g. 147-02)

## Ice Hockey Spectator Safety Nets

- No. 210-035** Spectator safety net in approx. **4 mm polyester, 35 mm mesh**.  
Colour: ○ £ 10.00 per m<sup>2</sup>
- No. 216-035** Spectator safety net in approx. **3 mm polyester, 35 mm mesh**.  
Colour: ○ £ 8.00 per m<sup>2</sup>

## Ice Hockey Goal Catch Nets

- No. 141** Catch net in approx. **3 mm polyester, 35 mm mesh**.  
Dimensions: 1.93 × 1.30 m.  
Colour: ○ £ 49.00 per pair
- No. 146** Catch net in approx. **4 mm polyester, 35 mm mesh**.  
Dimensions: 1.93 m × 1.30 m.  
Colour: ○ £ 68.00 per pair



**Surcharge for smaller quantities (each net):**  
(Spectator safety nets)

net under 5 m<sup>2</sup> + 100 %  
net under 10 m<sup>2</sup> + 35 %  
net under 20 m<sup>2</sup> + 20 %

**Please also refer to the product information on pages 6.1 and 6.2.** When ordering loose hanging nets, the required length must be increased by approx. 20 %.





No. 120-01

## Cycle Ball Goal Net

- No. 120** Goal net in approx. **3 mm high tenacity polypropylene**, 2 m high, 2 m wide, 80 cm deep, with a **mesh size of 10 cm**.  
Colour: ● £ 43.00 per pair

## Cycle Polo Goal Net

- No. 121** Goal net in approx. **3 mm high tenacity polypropylene**, 2 m high, 2 m wide, 80 cm deep, with a **mesh size of 4.50 cm**.  
Colour: ● £ 90.00 per pair

**If you require another depth to comply with the new cycle ball regulations (between 30 and 60 cm at the top and between 60 and 80 cm at the bottom), please contact us stating the exact specifications of the goal.**

## Water Polo Goal Nets

- No. 115** Goal net in approx. **3 mm high tenacity polypropylene**, width 3 m, height 1 m, depth 80 cm.  
Colour: ● £ 39.00 per pair
- No. 116** Goal net in approx. **4 mm high tenacity polypropylene**, width 3 m, height 1 m, depth 80 cm.  
Colour: ● £ 60.00 per pair



No. 115-01

## Nets for Indica and Deck Tennis

- No. 115** Goal net in approx. **3 mm high tenacity polypropylene**, width 3 m, height 1 m, depth 80 cm.  
Colour 01: Green £ 39.00 per pair
- No. 116** Goal net in approx. **4 mm high tenacity polypropylene**, width 3 m, height 1 m, depth 80 cm.  
Colour: ● £ 60.00 per pair

- No. 520** **29 mm powder-coated tubular steel posts** in three parts with adjustable tension cords and 4 ground anchors. For badminton, Indica and deck tennis.  
Maximum post height: 2.45 m £ 60.00 per set

**We recommend using item 5023 to support indica tournament nets (see page 3.6).**

Prices excluding VAT



Sand pit cover for Beach-Volleyball

## Sand pit cover

- No. 791** **Woven polyester mesh**, approx. **400 g per m<sup>2</sup>**, with hemstitch all the way round, incl. 4 corner cut outs.  
Colour: ● £ 9.00 per m<sup>2</sup>
- No. 7651** **PE air-permeable sheet**, approx. **220 g/m<sup>2</sup>**, with hollow seam all round, incl. 4 corner cut outs. **NEW**  
Colour: ● £ 7.00 per m<sup>2</sup>
- No. 7999** **Cover** from an additional section with reinforcement. £ 5.75 each
- No. 2110-600** **Leaded ballast cord**, ca. 600 g/m, for incorporating into hollow seam. £ 6.00 per metre
- No. 9998** **Chain**, hot-dip galvanised, ca. 800 g/m, for incorporating into hollow seam. **NEW** £ 8.00 per metre
- No. 2100** **Galvanised steel wire rope**, approx. 6 mm in diameter. £ 1.00 per metre
- No. 2023** **Stainless steel snap hook** with swivel eye. £ 2.00 each
- No. 9091** **Aluminium sleeve** for installation in the ground. £ 21.00 each
- No. 2109** This **ground anchor** consists of a 3 mm steel wire cable, 40 cm long, and loop. It is knocked into the ground using a round bar, 45 cm long, and then removed. When the cable loop is pulled, the anchor turns diagonally in the ground becoming securely anchored.  
**Resistance: approx. 100 kg** £ 28.00 each



No. 9091



No. 2109



Sand pit cover for Landing pit

● = 01 = green      ● = 015 = dark green

When ordering, please specify which colour you require!  
(e.g. 7651-015)

**Surcharge for nets/covers:**  
per net/cover

net under 5 m<sup>2</sup> + 100 %  
net under 10 m<sup>2</sup> + 35 %  
net under 20 m<sup>2</sup> + 20 %

**Additional abrasion protection**  
**from PVC tarpaulin on edge upon**  
**request!**



No. 640-01

## Hammer and Discus Safety Nets

Our hammer and discus safety nets are **manufactured in approx. 5 mm high tenacity polypropylene.**

**All hammer and discus safety nets are edged with 12 mm rope along the top and down the vertical selvages.**

**The netting in our hammer-throwing nets meets EN 1263-1 requirements!**

They can also be equipped with an attachment device for raisable hammer throw safety nets (see page 7.6, art. no. 635).

*Discus safety net for a standard 7-panel cage  
(cage size:  $7 \times 2.74 \text{ m} = 19.18 \text{ m}$ ).*

- No. 610** Hammer & Discus throwing safety net for 4 m high structures.  
**Net size:** 4.50 × 21 m long. Surround ropes attached on lateral and upper edges of net with 8 mm dia. cord.  
 Colour: ● £ 638.00 each

*Discus safety net conforming to new DLV (German Athletics Association) regulation 190.3 for a 7-panel cage with 2 additional 2 m wide tilting wings*

*(cage size:  $5 \times 3 \text{ m} + 2 \times 3.70 \text{ m} + 2 \times 2 \text{ m} = 26.40 \text{ m}$ ).*

- No. 612** Discus safety net for a cage height of 4 m.  
**Net size:** 4.50 m high and 27 m long.  
 Colour: ● £ 759.00 each

*Hammer throwing and discus safety nets for cages with 2 tilting panels 2 m wide.  
(cage size:  $7 \times 2.74 \text{ m} + 2 \times 2 \text{ m} = 23.18 \text{ m}$ ).*

- No. 620** **Hammer & Discus throwing safety net**, like item 610 but for a cage height of 4.50 m that rises to 5 m at the sides.  
**Net size:** rises from 5 to 5.50 m high, 25 m long.  
 Colour: ● £ 868.00 each
- No. 621** **Hammer & Discus throwing safety net**, as per No. 620, for 5 m high frames. **Net size:** 5.50 m × 25 m.  
 Colour: ● £ 868.00 each
- No. 630** **Hammer & Discus throwing safety net**, as per No. 620, for 5.50 m high frames. **Net size:** 6 m × 25 m.  
 Colour: ● £ 1,102.00 each
- No. 640** **Hammer & Discus throwing safety net**, as per No. 620, but for panel heights rising from 7 to 9 metres in the wing area.  
**Net size:** rising from 7.50 to 9.50 m × 26 m long.  
 Colour: ● £ 1,682.00 each

Where frames for double nets with a panel height of up to 5 m are used, Net 610 is used as the outer net and net No. 620 or 621 as the inner net. For panel heights up to 5.50 m net No. 621 is used as the outer net and net No. 630 as the inner net.

**Hammer throwing nets for other cage dimensions and indoor hammer throwing nets are available on request.**



Use of our hammer-throwing nets during the 2012 Southern German Athletics Championships in Wetzlar.



No. 635 Attachment system for lifting nets

**Hammer throwing safety nets** conforming to new DLV regulation 192.3 for a 9-panel cage with 2 additional 2 m wide tilting wings (cage size:  $9 \times 2.80 \text{ m} + 2 \times 2 \text{ m} = 29.20 \text{ m}$ ).

- No. 650** **Hammer throwing safety net** for a cage height of 7 m rising to 10 m. **Diagonal mesh.**  
**Net size:** 7.50 m rising to 10.50 m, approx. 31.50 m long  
 Colour: ● £ 1,840.00 each
- No. 651** **Hammer throwing safety net** for a cage height of 7 m rising to 10 m. **Square mesh.**  
**Net size:** 7.50 m rising to 10.50 m, 31.50 m long  
 Colour: ● ● £ 2,306.00 each

**Please note:**

**When ordering products no. 650 and 651, please be sure to give details of cage shape or attach a sketch!**

## Accessories for Hammer Throwing Nets

- No. 611** **Additional net for portable support frames** in case frame of 7 panels is supplemented with two additional frames. This set-up requires 2 nets of  $2 \text{ m} \times 5.50 \text{ m}$ . Material as No. 610.  
 Colour: ● £ 231.00 per pair
- No. 635** **System for securing hammer throwing nets.**  
 In order to make hammer and discus safety nets easy to assemble and dismantle, they are edged with 12 mm rope along the top and down the two front sides. Cable eyes and corresponding pull cords are integrated along the top for lifting the net (see photo). This system is suitable for all hammer and discus safety nets.  
 £ 155.00 per system
- No. 636** **Net ballast bag** made of small woven HDPE bands. Ballast not included. £ 5.00 each
- No. 637** **Set of 10 extra PP ropes**, approx. 6 mm thick and 10.80 m long, integrated into the height of the net with 1 rope per panel and attachment point. These ropes give the cage shape and prevent the netting from entering the throwing area.  
 £ 63.00 per set



The Test-meshes are attached to the finished net with special seals to indicate that they are from the same net batch which ensures the required quality control standard.



## Cricket Nets

- |   |   |
|---|---|
| <p><b>No. 2450</b> <b>Ball stopping net</b> of 2.3 mm, high tenacity polypropylene, mesh size 45 mm. <b>Width of net: 2.70 m</b><br/>Colour: ○ ● £ 10.00 per metre</p>  | <p><b>No. 2450-27</b> <b>Round wood</b>, painted green.<br/>Complete with guy ropes, runners and pegs.<br/><b>Length: 2.70 m</b> £ 33.00 each</p> |
| <p><b>No. 2451</b> <b>Ball stopping net</b> of 2.3 mm, high tenacity polypropylene, mesh size 45 mm. <b>Width of net: 3 m</b><br/>Colour: ○ ● £ 11.00 per metre</p>   | <p><b>No. 2451-30</b> <b>Round wood</b>, painted green.<br/>Complete with guy ropes, runners and pegs.<br/><b>Length: 3 m</b> £ 33.00 each</p>    |
| <p><b>No. 2452</b> <b>Ball stopping net</b> of 2.3 mm, high tenacity polypropylene, mesh size 45 mm. <b>Width of net: 3.30 m</b><br/>Colour: ○ ● £ 12.00 per metre</p>  | <p><b>No. 2452-33</b> <b>Round wood</b>, painted green.<br/>Complete with guy ropes, runners and pegs.<br/><b>Length: 3.30 m</b> £ 33.00 each</p> |
| <p><b>No. 2453</b> <b>Ball stopping net</b> of 2.3 mm, high tenacity polypropylene, mesh size 45 mm. <b>Width of net: 3.60 m</b><br/>Colour: ○ ● £ 13.00 per metre</p>  | <p><b>No. 2453-36</b> <b>Round wood</b>, painted green.<br/>Complete with guy ropes, runners and pegs.<br/><b>Length: 3.60 m</b> £ 33.00 each</p> |
| <p><b>No. 7710</b> Breathable plastic tarpaulin in <b>high tenacity polypropylene</b>, approx. <b>510 g/m<sup>2</sup></b> in tightly woven, flame-retardant fabric, and selvedge all the way round (see small picture above).<br/>Colour: ● ○ ● £ 12.30 per m<sup>2</sup></p> |    |

See page 6.3 for ball stopping nets in any dimensions required, in 2.3 mm dia., high tenacity polypropylene, mesh size 45 mm.  
Cricket netting for the professional – for indoors and outdoors.



## Baseball – a thriving sport from the USA

**It is a sport that awakens both players and spectators' passions.**

Intensive training is necessary to learn the best way to hit the ball and a ball which has been hit correctly goes a long way. Bringing it back either requires a volunteer or a lot of effort.

Therefore a **training tunnel is essential for stroke practice.**

**No. 200-045** Ball control net for training tunnel in **2.3 mm high tenacity polypropylene**, mesh size 45 mm. Made to measure.  
Colour: ● £ 4.00 per m<sup>2</sup>

**No. 209-045** Ball control net for training tunnel in **3 mm high tenacity polypropylene**, mesh size 45 mm. Made to measure.  
Colour: ● £ 4.00 per m<sup>2</sup>



For net attachment and tensioning accessories, see pages 6.5 and 6.6.

Please enquire for prices of complete baseball tunnels.

**Surcharge for nets:**  
per net

under 5 m<sup>2</sup> + 100 %  
under 10 m<sup>2</sup> + 35 %  
under 20 m<sup>2</sup> + 20 %

● = 01 = green

○ = 02 = white

● = 04 = blue

● = 06 = black

**When ordering, please specify which colour you require! (e.g. 2450-06)**

Prices excluding VAT



## Ball Safety Nets for Golf Ranges/Courses

Art.-No.	Description	Diameter approx. mm	Mesh size mm	Colour	£/m <sup>2</sup>
200-020-01	PP high tenacity, knotless, green	●	2.3	20	£ 7.00
200-020-015	PP high tenacity, knotless, dark green	●	2.3	20	£ 7.00
200-020-02	PP high tenacity, knotless, white	○	2.3	20	£ 7.00
200-020-06	PP high tenacity, knotless, black	●	2.3	20	£ 7.00
201-020-02	PP high tenacity, knotless, white	○	1.8	20	£ 5.00
201-020-06	PP high tenacity, knotless, black	●	1.8	20	£ 5.00
201-025-015	PP high tenacity, knotless, dark green	●	1.8	25	£ 4.00
201-025-06	PP high tenacity, knotless, black	●	1.8	25	£ 4.00
203-020-06	PP high tenacity, knotless, black	●	1.5	20	£ 4.00
203-028-06	PP high tenacity, knotless, black	●	1.5	28	£ 3.00
204-020-02	Polyester, knotless, white <b>(NEW)</b>	○	1.8	20	£ 6.15

**When ordering, please specify which colour you require!**

e.g. 164-02 = Net in white.

- = 01 = green      ○ = 02 = white      ● = 06 = black  
 ● = 015 = darkgreen      ● = 04 = blue

**Surcharge for smaller quantities per net:**

nets under 5 m<sup>2</sup> + 100 % | under 10 m<sup>2</sup> + 35 % | under 20 m<sup>2</sup> + 20 %

## Golf practice net

**No. 164** **Golf practice net**, consisting of steel poles that can be linked together, one polypropylene net at the front to stop high balls and another net at the back to stop balls rolling along the ground.

Size of main net: high 2.10 m, width 2.75 m made in **approx. 1.8 mm high tenacity polypropylene** with mesh size 20 mm.

Colour: ○ £ 146.00 each

**No. 169** **Replacement net** for item 164

Colour: ○ £ 49.00 each



No. 164 Golf practice net

Prices excluding VAT





No. 771-01

## Archery Protection Nets

Our protective nets are suitable for archery as a sport. They are not suitable for hunting archery. When assembling, the nets must not be tensioned but left slack like a curtain. This type of system will efficiently collect stray arrows. Each net should not be longer than 4 m.

**When installing a number of nets an overlap of 50 cm is recommended.**

**In the case of very intensive use, it is recommended that two layers of nets are installed.**

**No. 770** Archery net in very tightly woven polyester cloth, approx. 450 g/m<sup>2</sup>, width 2.40 m, selvedge all the way round and fitted with eyelets every 30 cm on the upper section (see photo). These nets can be hung using steel cables, see the accessories on page 6.6.

Colour: ● £ 65.00 per metre

**Only available in standard width.**

**No. 771** Archery net in high tenacity polypropylene, approx. 510 g/m<sup>2</sup> in tightly woven, flame-retardant fabric, fitted with eyelets every 30 cm on the upper section, and selvedge all the way round, **in any dimension.**

Colour: ● ○ ● £ 21.00 per m<sup>2</sup>



No. 770-04

**These nets can be hung using steel cables; see the accessories on page 6.6.**

**Surcharges for minimum quantities for article no. 771-01, 202-020-02 and 201-020-02 for each net**

nets under 5 m<sup>2</sup> + 100 % | under 10 m<sup>2</sup> + 35 % | under 20 m<sup>2</sup> + 20 %

## Protective Nets for Squash Courts

**No. 202-020** Catch net for squash courts in 1 mm knotless high tenacity polypropylene, 20 mm mesh. Made to measure  
Colour: ○ £ 3.00 per m<sup>2</sup>

**No. 201-020** Catch net for squash courts in 1.8 mm knotless high tenacity polypropylene, 20 mm mesh. Made to measure  
Colour: ○ £ 5.00 per m<sup>2</sup>

**The price of trapeziform nets is based on the longest and widest sides.**



No. 202-020-02

## Hammocks and Seating for Indoors and Out ...

- No. 40005** Suspended seat Model "Flair" in 5 mm high tenacity polypropylene.  
Colour: ● ● £ 51.00 each
- No. 40001** Suspended seat Model "Swing" in 15 mm Mahulan netting.  
Colour: ● ● £ 71.00 each



No. 40005-07 Model "Flair" + No. 10822 Support element "Sonio"

## "Sonio" Support Element

- No. 10822** Support element, Model "Sonio", height-adjustable for suspended seats. Base area 130 cm × 115 cm. Height can be adjusted between 200 cm and 240 cm. Made of steel tube 36 mm and 42 mm. Suitable for a load of 120 kg, weight 22 kg.  
Colour: ○ £ 140.00 each

## Hammocks and Hammock Frame

- No. 40003** Hammock Model "Heaven" with an unusual netting design (**Mahulan netting**) in weather-resistant **15 mm polypropylene**, making it extremely durable. The hammock has 2 shaping brackets and is supplied complete with fixing ropes and in a sales packaging (box) 105 cm × 26 cm × 12 cm.  
Colour: ● ● £ 51.00 each
- No. 40006** Hammock Model "Dream" in weather-resistant **5 mm polypropylene**, a pleasantly soft material. The hammock has 2 shaping brackets and is supplied in sales packaging like the "Heaven" model.  
Colour: ● ● £ 48.00 each
- No. 10850** "Easy Stand" hammock stand for the "Heaven" and "Dream" models. Length adjustable from 320 cm to 375 cm, extremely stable and safe. Suitable for loads up to 120 kg.  
Colour: ● £ 97.00 each



No. 40003-05 Model "Heaven" + No. 10850 hammock stand "Easy Stand"

- = 01 = green    ● = 04 = blue    ● = 06 = black    ● = 08 = hempcoloured  
○ = 02 = white    ● = 05 = yellow    ● = 07 = red    ● = 66 = silver

When ordering, please specify which colour you require! (e.g. 40005-07)!



Site: PARCABOUT' MANGOFIL in MARTINIQUE (Photo: Pierre Sacaze)

## "A walk in the trees" adventure course

This kind of facility can be found in France and Italy and is very popular with both professional and novice climbers.

The soft netting is not only good for your balance and coordination but also the ideal material to protect you when you fall.



Site: PARCABOUT' MANGOFIL in MARTINIQUE (Photo: Pierre Sacaze)

## Net Climbing Course

**No. 212-045** Safety net made of approx. 5 mm high tenacity polypropylene, mesh size 45 mm.

Colour: ● ● ● ●      £ 7.00 per m<sup>2</sup>  
For other colours, see page 6.4.

**No. 211-045** Safety net made of approx. 4.5 mm polyester, mesh size 45 mm.

Colour: ●      £ 9.00 per m<sup>2</sup>

**Surcharge for nets:**  
per net

under 5 m<sup>2</sup> + 100 %  
under 10 m<sup>2</sup> + 35 %  
under 20 m<sup>2</sup> + 20 %

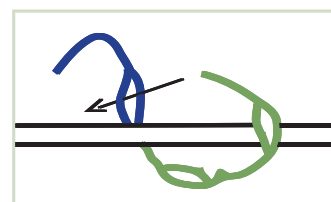

Photo: PRISME S.A., 73 St-Jean de Maurienne, Frankreich

## HUCK – Isilink (DBGM)

No limits to the possibilities for fixing and adjustment without metal components

- No. 38030** Isilink line in high tenacity polypropylene, **3 mm dia.**  
 Breaking strain: 80 daN  
 Metres per reel: 1000 m  
 Colour: ● £ 70.00 per roll
- No. 38040** As above but **4 mm dia.** Breaking strain: 100 daN  
 Metres per reel: 600 m  
 Colour: ● £ 77.00 per roll
- No. 38060** As above but **6 mm dia.** Breaking strain: 160 daN  
 Metres per reel: 500 m  
 Colour: ● £ 81.00 per roll
- No. 38080** As above but **8 mm dia.** Breaking strain: 290 daN  
 Metres per reel: 250 m  
 Colour: ● £ 76.00 per roll
- No. 38100** As above but **10 mm dia.** Breaking strain: 360 daN  
 Metres per reel: 150 m  
 Colour: ● £ 83.00 per roll



Step 1

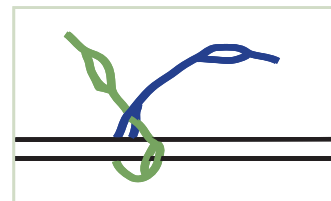

Step 2

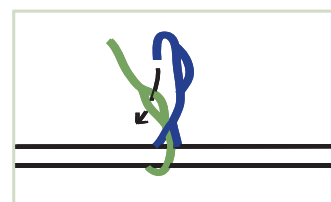

Step 3

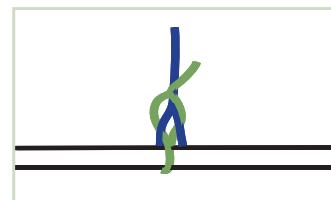

Step 4

### Possible Applications:



- = 01 = green      ● = 06 = black      ● = 08 = hemp coloured  
 ● = 04 = blue      ● = 07 = red

When ordering, please specify which colour you require! (e.g. 38030-01)



No. 280

No. 281

No. 2803

## Skipping Ropes for Gymnastics

- |                    |  |                |                 |   |                |
|--------------------|--|----------------|-----------------|---|----------------|
| <b>No. 250</b>     | <b>Skipping rope</b> in grey hemp, centre reinforced to 10 mm, with knots at the end.<br><b>Length: 250 cm</b> | £ 12.00 per 10 | <b>No. 2803</b> | <b>Skipping rope, 280 cm long</b> , as article 280 but with wooden handles and swivels, length of rope adjustable.<br>Colour of wooden handles: natural, varnished. | £ 3.50 each    |
| <b>No. 280</b>     | <b>Skipping rope</b> in grey hemp, centre reinforced to 10 mm, with knots at the end.<br><b>Length: 280 cm</b> | £ 12.00 per 10 | <b>No. 281</b>  | <b>Skipping rope</b> in grey hemp, centre reinforced to 11 mm, with knots on the ends.<br><b>280 cm long</b> – a particularly heavy quality.                        | £ 15.00 per 10 |
| <b>No. 280/300</b> | <b>Skipping rope</b> like no. 280, but <b>length: 300 cm</b>   | £ 14.00 per 10 |                 |   |                |

## Swing Ropes

- |                |   |             |
|----------------|---|-------------|
| <b>No. 290</b> | <b>Swing rope</b> in grey hemp, <b>8 m long</b> , centre reinforced to 12 mm, loops and snap hooks on the ends. | £ 6.20 each |
| <b>No. 291</b> | <b>Swing rope</b> in grey hemp, as article 290 but <b>6 m long</b> , with loops on both ends.                   | £ 6.20 each |



No. 290



## Gymnastic Skipping Ropes in fashionable colours

**No. 295** **Skipping rope** for gymnastics in current fashion colours, braided to comply with the international standard, 9 mm dia., **3 m long** and of consistent thickness.

£ 2.00 each

**No. 297** **Skipping rope** for gymnastics in current fashion colours, braided to comply with the international standard, 9 mm dia., **3.30 m long** and of consistent thickness.

£ 2.00 each

**No. 2950** **Skipping rope**, same as No. 295, **per pack of 10 ropes** of assorted colours, supplied in a clear plastic pack.

£ 20.00 per pack

**No. 35090** **Skipping rope line**, same as No. 295, supplied on reels of 100 m.

**NEW**

£ 57.00 per reel

**No. 294** **Skipping rope** for gymnastics in high tenacity polypropylene, 8 mm dia., 300 cm long and of consistent thickness.

Colour: ○ £ 2.00 each  
(while stocks last)



No. 2950



No. 35090

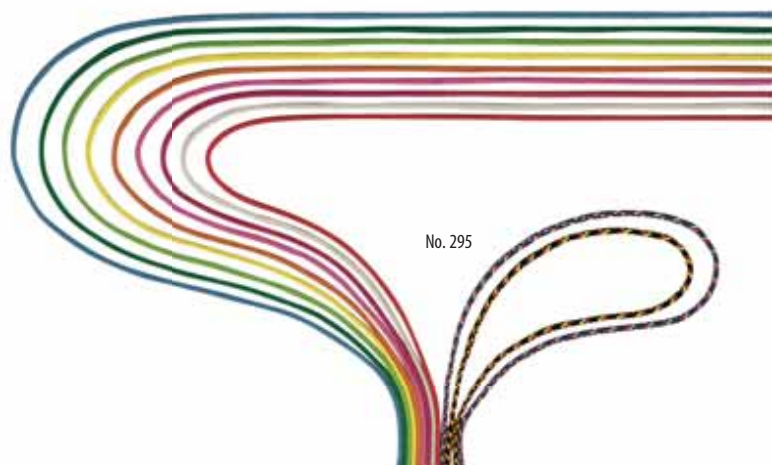

No. 295

## Colour key for Nos. 295 / 297 / 35090

Colour-No. 121 = ◆ fashion blue

Colour-No. F3 = ◆ fashion yellow

Colour-No. 188 = ◆ fashion violet

Colour-No. 600 = ◆◆ black/red/gold

Colour-No. 117 = ◆ fashion green

Colour-No. 102 = ◆ fashion orange

Colour-No. 900 = ◇ fashion white

Colour-No. 610 = ◆◆ blue/white/red

Colour-No. F2 = ◆ fashion light green

Colour-No. F1 = ◆ pink

Colour-No. 114 = ◆ fashion red

(Colour-No. 600 and 610 only for Art.-No. 295!)

**Please quote the colour number when ordering!**

Prices excluding VAT



Double Dutch

## Neon Double Dutch Skipping Ropes

**Double Dutch** is a completely new challenge for all those who love skipping ropes. For the person jumping the rope, good coordination is essential and swinging the rope also requires skill.

- No. 306**     **Neon Double Dutch swing rope**, length 6 m  
(see the neon ropes colour index for a list of the colours  
in which they are available):
- £ 10.00 per pair

## "Neon Ropes"

"Neon Ropes", the **up-to-date skipping rope** for the modern form of skipping. We supply the synthetic rope in 4 neon colours and 4 different sizes.

**Please state the colour number (see illustration) when ordering!**

- No. 307**     **"Neon Rope"**, 2.13 m long.     £ 3.00 each
- No. 308**     **„Neon Rope“**, 2.43 m long.     £ 3.00 each
- No. 310**     **„Neon Rope“**, 3.00 m long.     £ 3.00 each

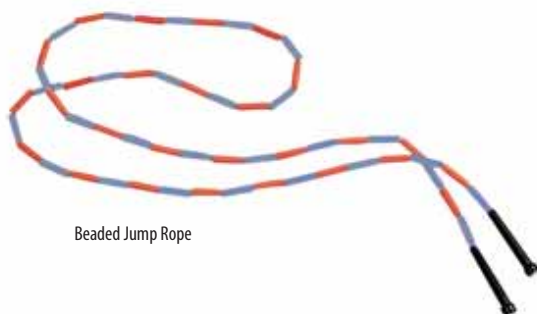

Beaded Jump Rope

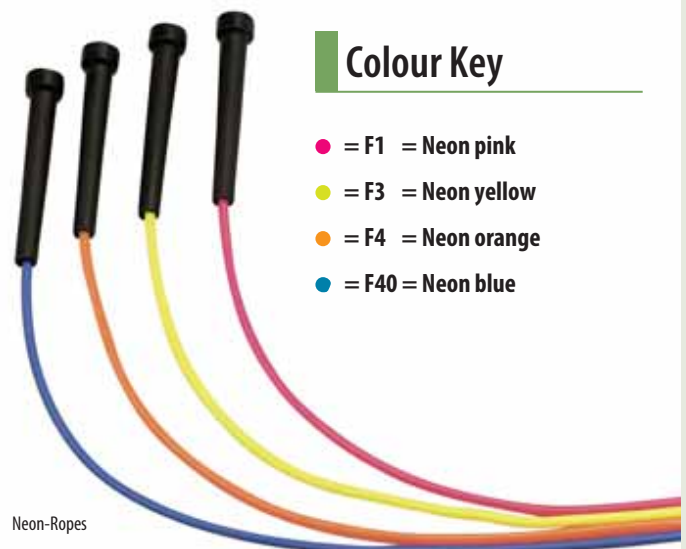

Neon-Ropes

### Colour Key

- = F1 = Neon pink
- = F3 = Neon yellow
- = F4 = Neon orange
- = F40 = Neon blue

## "Beaded Jump Ropes"

**New skipping rope** consisting of a nylon rope threaded with colourful plastic beads like a string of pearls and with black plastic handles.

Attractive lightweight design makes it easy to swing.

- No. 320**     Beaded skipping rope, **3 m long**.  
Colour: 34 ●     £ 3.00 each

**Warning: the jump and skipping ropes shown on this page are not suitable for children under 3.**



## "Tug of War" Rope

Tug of War ropes in soft lay approx. **20 mm dia. polypropylene**, with red marker and plastic coated ends, hemp coloured.

<b>No. 3310</b>	length 10 m	£ 32.00 each
<b>No. 3312</b>	length 12 m	£ 35.00 each
<b>No. 3314</b>	length 14 m	£ 37.00 each

Tug of War ropes in soft lay **25 mm dia. polypropylene**, with Red marker in the middle and plastic coated ends. Hemp coloured

<b>No. 3410</b>	length 10 m	£ 40.00 each
<b>No. 3412</b>	length 12 m	£ 43.00 each
<b>No. 3414</b>	length 14 m	£ 48.00 each
<b>No. 3415</b>	length 15 m	£ 50.00 each
<b>No. 3423</b>	length 23 m	£ 66.00 each

Tug of War ropes in soft lay **33 mm dia. Natural fibre** with Red marker in the middle and plastic coated ends.

<b>No. 3515</b>	length 15 m	£ 85.00 each
<b>No. 3523</b>	length 23 m	£ 105.00 each

## Balancing Rope

**No. 366** **Balancing Rope** in 70 mm dia. multifilament polypropylene, 2 m long. All other lengths on request.  
Colour: ● £ 70.00 each

## Circular Rope

**No. 3300** **Circular Rope** in soft lay 20 mm dia. polypropylene, with spliced join, length 16 m. Hemp coloured  
£ 41.00 each



Tug-of-war rope

**Balancing rope exercises help develop strength and promote supple muscles in legs and feet.**



No. 366-04





## Climbing Ropes for Gymnasiums

Includes a steel eye bracket for attachment and a plastic anti-fray sleeve at end. The total length indicated includes the attachment eye bracket.

### Soft lay climbing ropes for gymnasiums in Natural Fibre.

<b>No. 36400</b>	length 4.00 m, 30 mm dia.	£ 44.00 each
<b>No. 36450</b>	length 4.50 m, 30 mm dia.	£ 46.00 each
<b>No. 36475</b>	length 4.75 m, 30 mm dia.	£ 47.00 each
<b>No. 36500</b>	length 5.00 m, 30 mm dia.	£ 49.00 each
<b>No. 36550</b>	length 5.50 m, 30 mm dia.	£ 51.00 each
<b>No. 36000</b>	length per additional metre	£ 6.00 per metre

### Soft lay climbing ropes for gymnasiums in Natural Fibre.

<b>No. 37400</b>	length 4.00 m, 33 mm dia.	£ 46.00 each
<b>No. 37450</b>	length 4.50 m, 33 mm dia.	£ 49.00 each
<b>No. 37500</b>	length 5.00 m, 33 mm dia.	£ 51.00 each
<b>No. 37550</b>	length 5.50 m, 33 mm dia.	£ 53.00 each
<b>No. 37600</b>	length 6.00 m, 33 mm dia.	£ 55.00 each
<b>No. 37000</b>	length per additional metre	£ 6.50 per metre
<b>No. 36001</b>	All climbing ropes can be supplied with a back spliced end as a foot-knot.	£ 6.50 each

No. 36400



Other lengths to special order!

## Gymnastic Rings for the Gymnasiums

- No. 401** **Complete set** consisting of laminated wood rings and chain, long hemp ropes 16 mm in diameter and ballast weights. Available in any length. Price for a total length of 12 m. £ 205.00 per set

## Championship Ring set for the gymnast

- No. 402** **Complete set** consisting of 70 cm long leather straps, no buckle, laminated wood rings and plastic-coated steel wire ropes with compressed and cushioned ball bearing suspension, adjustable up to 3 cm. Price for a suspension height of 5.50 m (other suspension heights possible). £ 255.00 per set

**Please note:** The leather straps should be greased well 2 – 3 times a year!

## Gymnastic Rings

- No. 400** **Wooden rings** with grooves, 28 mm dia. × 24 cm inside diameter. Hemp coloured £ 70.00 per pair

## Lunge reins

- No. 330** **Lunge reins** in 12 mm specially braided **polypropylene** rope, with splice at both ends. Colour: ● £ 4.00 per metre

- No. 332** **Lunge rein**, improved design made of 12 mm very high tenacity **polyester** rope. Breaking strength approx. 3000 daN with splice at both ends. This design has limited extension and is less abrasive. Colour: ● £ 5.00 per metre

- No. 2015** **Aluminium Safety Hooks.** Longitudinal tensile strength: approx. 22 kN. £ 9.00 each



## Fistball Rope, length 21 m

- No. 300** Ropes for fistball in 5 mm nylon braid, red/white alternating every 20 cm, with swivel on end. £ 21.00 each
- No. 316** **Fistball tape** conforming to the latest regulations. Made of red and white wind-permeable polyethylene fabric with a loose threaded cord for variable tensioning. 19.80 m long and approx. 5 cm wide. £ 65.00 each
- No. 317** **Fistball tape** made of red and white wind-permeable polyethylene fabric with a **sliding buckle** at both ends for variable tensioning. 19.80 m long and approx. 5 cm wide. £ 65.00 each



## Rope for Headball

- No. 303** **Headball rope** in 5 mm nylon braid, 12 m long, with swivel-snap hook and loop. £ 8.00 each

## Bands for Sitball

Sport for the handicapped

- No. 380** A 5 cm wide band, air-permeable, red/white, 8.80 m long with adjustable buckle on both ends. £ 41.00 each

## Prellball Band

for teams of 2 to 4 players

- No. 318** **Prellball band** in 2.50 cm width, plastic coated woven nylon for a team of 2. Band length 6 m, with loops on both ends, red/white. £ 32.00 each
- No. 319** **Prellball band** as No. 318, for team of 4 players. Length 8 m £ 40.00 each



## Gymnastic Laces

6 mm braided elastic cord, red and white, with plastic hooks on both ends, for use in a wide range of gymnastics and games.

- No. 370** 8 m length £ 6.00 each
- No. 371** 10 m length £ 7.00 each
- No. 372** 12 m length £ 8.00 each

## Gymnastic Circle (Magic circle)

- No. 375** 6 mm braided **elastic cord**, red and white, endless, with plastic clip for adjusting the size of the circle. Length 20 m £ 17.00 each



Other lengths available on request.



## Beach Volleyball Tournament Nets for a Playing Area of 9 × 18 m

**Tournament nets** with polyester rods sewn into the sides, black netting.

**Dimensions:** 9.50 × 1 m, mesh size 10 cm with a 75 mm wide, coloured band all the way round.

**No. 5044-06-F1** **Tournament net** for Beach Volleyball in **3 mm polyester**, knotless netting, with an 11.7 m Kevlar cable along the top and a 4 mm tensioning rope at the bottom, polyester band and fibre glass reinforcement dowel, 4-point suspension and 4 tensioning cords with snap buckles, with **DVV beach test mark**.  
With banding all around in neon pink.

£ 128.00 each

**No. 5044-06-F40** **Tournament net** for Beach Volleyball in **3 mm polypropylene**, knotless netting, with 11.7 m Kevlar cable along the top and a 4 mm tensioning rope at the bottom, polyester band and fibre glass reinforcement dowel, 4-point suspension and 4 tensioning cords with snap buckles, with **DVV beach test mark**. With banding all around in blue.

£ 117.00 each

**No. 514-06-F3** **Tournament net** for Beach Volleyball in **3 mm polyester**, knotless netting, with 11.7 m Kevlar cable along the top and a 4 mm tensioning rope at the bottom, polyester band and fibre glass reinforcement dowel, and 4 tensioning cords at the sides. With banding all around in Neon Yellow with **HUCK logo on top row**.

£ 108.00 each

for No. 5044-06-F1  
and No. 5044-06-F40



## Beach Volleyball Tournament Nets for a Playing Area of 8 × 16 m

In 2001, the world international volleyball federation, the FIVB, decided to adopt the rally point method of scoring for beach volleyball and reduce the size of the playing area for a trial period. The dimensions used in international tournaments are now 8 × 16 m instead of 9 × 18 m.

This means that volleyball nets and boundary markings of other sizes (8.50 × 1 m and 8 × 16 m respectively) are now required.

**Our boundary marking No. 555 (page 9.3) can be adjusted to 8 × 16 m and is therefore suitable for use with this item.**

**Tournament net** with polyester rods sewn into the sides, black netting.

**Dimensions:** 8.50 × 1 m, mesh size 10 cm with an 80 mm wide, coloured band all the way round.

**No. 512-06-F3** **Beach volleyball tournament net** in approx. **3 mm knotless polypropylene** with a **10.70 m Kevlar** cord at the top and tensioning rope at the bottom. polyester band at the sides with fibreglass dowel reinforcement, **4-point suspension** and 4 tensioning cords with snap lock. 80 mm wide, **neon yellow band all the way round**.

£ 106.00 each



## Beach Volleyball Training Nets for a Playing Area of 9 × 18 m

We now offer beach training nets in yellow with a blue headband.

**Leisure and training nets** in regulation dimensions: **9.50 × 1 m**, mesh size 10 cm with an 11.70 m steel cable (3 mm dia.) at the top and coloured headband.

**No. 513-06**

**Beach volleyball net** made of approx. **2 mm black polyethylene cord**, with tape, 75 mm wide and available in **various neon colours**, all the way round.

Colour: ● ● ● £ 71.00 each

**No. 509-06-F1** **Beach volleyball net** made of approx. **2 mm black polyethylene cord**, with tape along the top, 50 mm wide, and nylon tension cord (no steel cable).

**No. 513-05**

**Beach volleyball net** in **2.3 mm yellow polypropylene**, knotless netting. With an 80 mm wide, **blue band all the way round**.

Colour: ● £ 71.00 each

**No. 509-05-F40** **Beach volleyball net** in **2.3 mm yellow polypropylene**, knotless netting. With an 80 mm wide blue headband at the top.

**No. 9084**

Beach volleyball nets 513-06-F3, 513-06-F40 and 513-05-F40 can also be supplied with a **Kevlar cable** for an extra charge.

£ 8.00 each

£ 37.00 each

● = F1 = Neon pink ● = F3 = Neon yellow ● = F40 = Neon blue  
Please quote the colour number when ordering!



No. 513-05-F40

## Beach Volleyball Training Nets for a Playing Area of 8 × 16 m

**Leisure and training nets** in regulation dimensions: **8.50 × 1 m**, mesh size 10 cm, with an 10.70 m long bracing cable at the top. With coloured fastening tape.

**No. 518-06**

**Beach volleyball net** made of approx. **2 mm black polyethylene cord**. With a **75 mm wide fastening tape all the way round** in assorted neon colours and tension cord, with steel cable at the top and polyethylene tension cord at the bottom.

Colour: ● ● £ 67.00 each

**No. 508-06** **Beach volleyball net** made of approx. **2 mm black polyethylene cord**. With a **50 mm wide fastening tape at the top** in assorted neon colours and tension cord.

Colour: ● ● £ 29.00 each

See page 9.3 for beach volleyball net post accessories.

See page 9.3 for play area boundary marking.

## Professional Beach Volleyball Accessories

- No. 5028** **DVV-approved one piece Antennae Set** for Beach Volleyball, length 1.80 m complete with polyester antenna support pocket in yellow plastic coated polyester webbing and boundary marker.  
Colour: ● £ 35.00 per pair
- No. 5027** **Antenna support pocket** for Beach Volleyball in plastic coated woven polyester with boundary marker band, high frequency welded.  
Colour: ● £ 22.00 per pair
- No. 556** **Boundary marking** for beach volleyball, professional version, 9 × 18 m (can be adjusted to 8 × 16 m), with adjustable fibre-glass reinforced corner pieces, **DBGM**, 50 mm wide PP webbing and markings in the centre. Complete with 4 sand anchor plates and bungee stretch cords.  
Colour: ● £ 91.00 each
- No. 555** **Court marking** 9 × 18 m (can be adjusted to 8 × 16 m), improved design version, with adjustable design reg'd plastic corner pieces, 50 mm wide polyester webbing strap and markings in the centre. Complete with 4 plastic ground anchors 23 cm long and bungee elastic cords.  
Colour: ● £ 58.00 each
- No. 554** **Court marking**, like article-no. 555, but with the size of: **8 × 16 m**  
Colour: ● £ 56.00 each

Beach area covers, see page 7.4!



No. 550-04



No. 560



No. 540



No. 556-04



No. 5027-05



No. 555-04 (section)

## Leisure Beach Volleyball Accessories

- No. 5029** **Two piece Volleyball Antennae**, length 1.8 m, complete, with polyester antenna support pocket as No. 5028-05.  
Colour: ● £ 38.00 per pair
- No. 50271** **Antenna support pocket** for beach volleyball with **Velcro fastener** for quick and simple fastening net (without antennae).  
Colour: ● £ 24.00 per pair
- No. 550** **Court marking** 9 × 18 m (not adjustable), in woven polyester webbing, 50 mm, with loops at each corner and centre marking. Design in accordance with DVV requirements. Rolled on to a plastic reel. Complete with 4 anchoring pins.  
Colour: ● £ 52.00 each
- No. 553** Court marking as 550-04, but 8 × 16 m (not adjustable).  
Colour: ● £ 51.00 each
- No. 552** **Court marking** 9 × 18 m (not adjustable), consisting of 25 mm wide strip with loops at each corner. Rolled on to a plastic reel. Complete with 4 anchoring pins.  
Colour: ● £ 34.00 each
- No. 560** **Sand Kit**, comprising of:  
– 4 triangular sand plates with bungee cords for bracing the uprights.  
– 4 circular sand plates with bungee cords for bracing the volleyball court marking.  
– 2 round post discs as bottom support for the uprights.  
£ 32.00 per set
- No. 540** **Volleyball Net Transport and Storage Bag** in lightweight woven nylon.  
Length: 1.05 m, Diameter: 25 cm £ 11.00 each



## Beach Volleyball – Complete Sets

No. 5250

### Beach net kit

Consisting of:

**2 net posts approx. 2.50 m**, in three sections, with tool for fixing them firmly into the ground.

**4 easy-to-fix tension belts**, 25 mm.

**2 Kevlar tension cords** 6 m for bracing between the tension belts, the net and the posts.

**Beach volleyball net**, 9.5 × 1 m, with 10.40 m Kevlar tension cord, with wide fastening tape in neon yellow (item 514A-06-F3).

**Boundary marking**, width 50 mm, in blue, 9 × 18 m (adjustable to 8 × 16 m).

**4 special sand screws**

£ 470.00 per set

The set is supplied in a carry bag.



No. 5250

The Huck solution to the problem of transporting complete leisure sets on holiday and for leisure use.



Beach net kit, No. 5250, fitted out with clamp free fastenings

No. 5200

### Leisure net kit

for normal playgrounds, consisting of:

**Net post set** of 2 powder-coated steel rod posts (29 mm diameter), in three sections, with adjustable bracing cords and 4 ground anchors. Maximum post height: 2.45 m.

**Beach volleyball net** 9.5 × 1 m, with wide pink fastening tape.

**Boundary marking**, width 25 mm, in red, 9 × 18 m.

**Sand kit for setting up on sand.**

£ 195.00 per set

The set is supplied in a carrier bag.



No. 5200

This kit helps the casual Volleyball player become accustomed to standard playing areas.

● = 04 = blue    ● = 05 = yellow    ● = 07 = red

Please quote the colour number when ordering!



## Net Sets for Volleyball and Soccer-Tennis for standard and smaller playing areas

Net, net poles and court boundary marking as a complete set. Net with coloured surround, suppliable in 3 modern colours.  
For fun at the beach, on grassed areas or in leisure parks.

A standard court set consists of:

**1 Leisure net** made of approx. 2 mm polyethylene cord, mesh size 100 mm, 9.50 m long, 1 m high, colour black.

**1 Court marker**, 9 × 18 m, made of a 25 mm wide, red strip, with loops at each corner, wound onto a plastic reel, 4 ground anchors.

**1 Set of Net Support Posts**, consisting of 2 29 mm powder-coated tubular steel poles in 3 sections, with adjustable tensioning cords and 4 ground anchors. Maximum pole height: 2.45 m

No. 5150

Colour for headband:



£ 105.00 per set

A set for a smaller playing area consists of:

**1 Leisure net** made of approx. 2 mm polyethylene cord, mesh size 100 mm, 6 m long × 1 m high. Colour black

**1 Court marker** band in 25 mm wide, red, woven polyester, 5.18 × 13.40 m, with loops at each corner, wound onto a plastic reel, 4 ground anchors.

**1 Set of Net Support Posts**, in 29 mm powder coated steel tubes supplied in 3 sections, with adjustable tensioning cords and 4 ground anchors. Maximum height of the posts: 2.45 m.

No. 5100

Colour for headband:



£ 90.00 per set

The sets are supplied in a carry bag.



Colour for headband



Set and carry bag

Prices excluding VAT





No. 606-06-F3: Beach Badminton Net

## Beach-Badminton

**No. 606-06 Beach Badminton Net;** in nylon, approx. 1 mm, black, 6 × 0.76 m, with nylon tensioning rope, **headband in 3 different colours:**

Neon coloured headband



£ 23.00 each

● = F1 = Neon pink   ● = F2 = Neon green   ● = F3 = Neon yellow

Please quote the colour number when ordering!



No. 520: Support posts

## Leisure Badminton Net Accessories

**No. 830-01 Badminton net for leisure;** knitted polyethylene netting in panels, 6 m long × 70 cm height (see photo).  
Colour 01: Green with upper selvedge in White  
£ 12.00 each

**No. 520 Support posts** for badminton nets, Indiac and deck tennis. High quality set of 2 29 mm posts, in 3 sections, powder coated and supplied with guy ropes and 4 ground anchor pins. Height of the poles: maximum 2.45 m.  
£ 60.00 per set

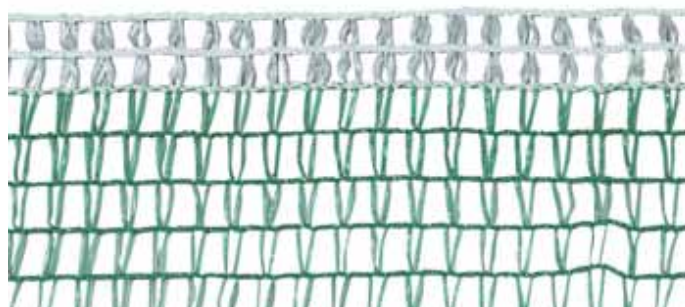

No. 830-01: Badminton net for leisure



No. 6060-F2

## Nets for Badminton and Soccer-Tennis

A complete set consisting of a net, net posts and boundary marking.  
 The net tape is available in 3 fashionable colours.  
 Great fun for young and old.

**A kit includes:**

**1 Leisure net** in approx. 1 mm nylon cord with nylon tension cord, mesh size of 18 mm, 6 m long x 76 cm height. Net colour 06: Black

**1 Play area marker band**, 5.18 x 13,4 m in woven red polyester, 25 mm in width, with 4 eyelets at corners and supplied on plastic, complete with 4 ground anchor pins.

**1 Set of net posts** comprising two 29 mm powder-coated steel posts in 3 sections, with adjustable anchor cords and 4 ground anchor pins.  
 Maximum height of posts: 2.45 m.

No. 6060

Neon coloured headband



£ 86.00 per set

The set is supplied in a carry bag.



● = F1 = Neon pink

● = F3 = Neon yellow

● = F2 = Neon green

● = 06 = Black

Please quote the colour number when ordering!



Colour for headband

Prices excluding VAT



No. 6200-01



No. 8200

## Badminton-Nets Set

for Leisure, with integral fibreglass/polyester posts

**No. 6200-01** **Badminton net for leisure** in rot-proof knitted polyethylene. Integral fibreglass/polyester net posts can be fitted together, which reduces their length for transportation. Quick and easy to assemble.

**One set consists of:**

**1 Leisure Badminton net** (length 6 m, height 70 cm) with integral **polyester/fibre glass poles**. Pole length: approx 1.80 m (90/90)  
Pole dia.: 12 mm: **2 tension cords and 4 ground anchor pins.**

£ 38.00 each

**Packing:** in attractive sales box with 3 photographs showing use of the equipment.

## Leisure Tennis Net Set

with integral fibreglass/polyester posts

**No. 8200** Manufactured in rot-proof knitted polyethylene. The integral, flexible fibreglass reinforced polyester net posts have the advantage that they are permanently fixed to the net and therefore cannot be lost.

The net is also therefore extremely easy and quick to set up.  
**Complete with 2 guy ropes and 2 anchor pins.**

£ 29.00 per set

Length: approx. 6.00 m  
Height: approx. 0.80 m  
Post length: approx. 1.10 m  
Post dia.: approx. 12 mm

Particularly suitable for leisure sport and camping.

## Paddle-Tennis net

A **new type of trend sport**, which is widespread in Spain and South America, is now taking off in the UK too.

It is a return play game like tennis, for courts 20 × 10 m in size.

**No. 8430** **Paddle-Tennis net** in approx. **3 mm** high tenacity polypropylene, knotless, mesh size approx. 45 mm. Net length: 10 m, net height: approx. 92 cm, with a pvc-coated steel cable (3.4/4.5 mm) along the top and also with PES tape along the top, 100 mm wide (50 mm).  
Colour: ● £ 76.00 each

Please state the distance between the posts when ordering!

**No. 9052** **Centre strap** made of 100% polyester with plastic snap buckle and stainless steel snap hooks.  
£ 8.00 each  
**(other accessories, see page 5.4)**

Printed head band available upon request!



No. 8430-06





No. 8231-06-F3

## Beach Tennis Tournament Nets

- No. 8231-06** **Beach tennis tournament net** made of approx. 3 mm high tenacity polypropylene. Mesh size: 45 mm. 80 mm wide neon yellow tape all the way round and Kevlar tension cord, 11.70 m long, along the top. Polyester rods and 4-point suspension with 4 tension cords and fastener at the sides.  
Dimension: 9.50 m × 1 m  
Colour: F3 ● £ 145.00 each

## Beach Tennis Court Marking

- No. 555** **Markings for play area** of 9 × 18 m with adjustable DBGM plastic corner pieces (adjustable to 8 × 16 m), 50 mm wide PES band with logo in the centre. Complete with 4 plastic ground anchors 23 cm long and bungee stretch cords.  
Colour: ● £ 58.00 each
- No. 554** **Court marking**, like article-no. 555, but with the size of: 8 × 16 m  
Colour: ● £ 56.00 each

## Beach Tennis Training Nets

- No. 8220-06** **Beach tennis training net** made of approx. 2.3 mm high tenacity polypropylene. Mesh size: 45 mm, with **above** 160 mm wide (80 mm when folded) fastening tape in neon yellow and Kevlar tension cord 11.70 m long, and below with a 12 m length of 5.5 mm cord (patent applied for), and with lugs and connecting laces (without polyester bars) at the 4 corners.  
Size: 9.50 m × 1 m.  
Colour: F3 ● £ 65.00 each
- No. 8221-06** **Beach tennis training net** made of approx. 2.3 mm high tenacity polypropylene. Mesh size: 45 mm, **with neon yellow ribbon binding all the way round**, being 160 mm (80 mm when folded) at the top, and 80 mm (40 mm when folded) at the sides and bottom, and having Kevlar tension cord 11.70 m long at the top and, below, 12 m length of 5.5 mm cord (patent applied for), and with lugs and connecting laces at the 4 corners, **and with polyester bars at the sides**.  
Size: 9.50 m × 1 m.  
Colour: F3 ● £ 108.00 each
- No. 8222-06** **Beach tennis training net** as no. 8221-06, but:  
Size: 8.50 m × 1 m  
Colour: F3 ● £ 102.00 each

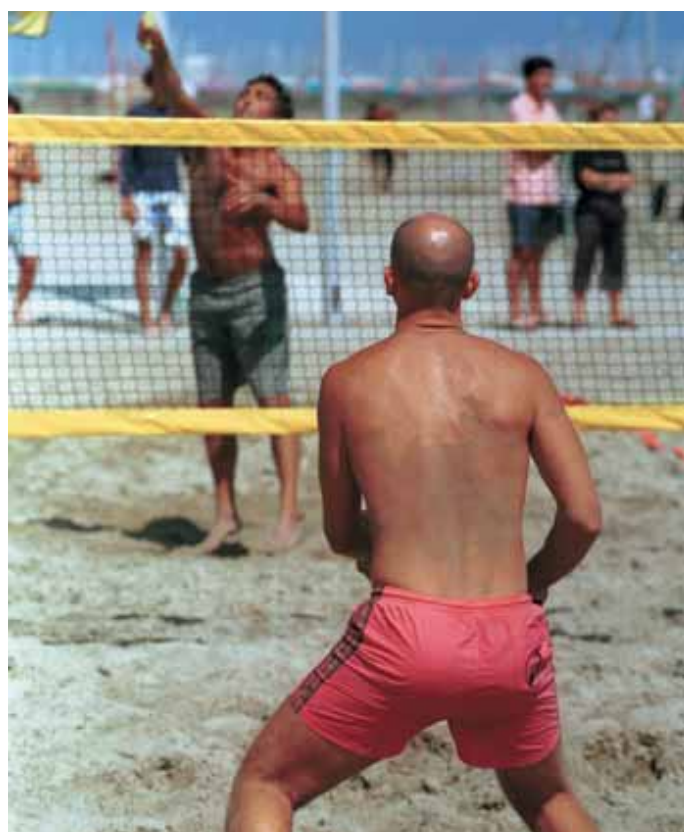



## Complete beach Tennis Kit

No. 8250

**Beach tennis kit** consisting of:

**2 net posts approx. 1.90 m**, in three sections, with tool for fixing them firmly into the ground.

**4 easy-to-fix tension belts**, 25 mm.

**2 Kevlar tension cords** 6 m for bracing between the tension belts, the net and the posts.

**Beach tennis net**, 9.5 × 1 m (with 10.40 m Kevlar tension cord) with neon yellow fastening tape all the way round (our No. 8221A-06-F3).

**Boundary marking**, width 50 mm, in blue, 9 × 18 m (adjustable to 8 × 16 m).

**4 special sand screws**

£ 494.00 per set



No. 8250

## Beach-KOMBI-Set

**This Beach Kombi set can be set up for beach volleyball, beach tennis, or beach badminton**

No. 6220

**Beach Kombi set** consisting of:

**Net post set** of 2 powder-coated steel rod posts, in three sections, with adjustable bracing cords and 4 ground anchors. Maximum post height: 2.45 m.

**Kombi net**, 8.50 × 0.90 m made of approx. 1.5 mm polypropylene, mesh size 30 mm, with neon yellow fastening tape.

**Boundary marking**, width 5 mm, in yellow, 8 × 16 m.

£ 157.00 per set

**Each set is supplied in a carry bag.**



No. 6220

● = 04 = blue      ● = F3 = Neon yellow

**Please quote the colour number when ordering!**



No. 114-05

## Beach-Handball

*Dimensions: width 3.10, height 2.10 m, top depth 80 cm, bottom depth 1 m.*

- No. 114 Beach Handball Goal Nets** in 4 mm high tenacity polypropylene. Mesh size: 10 cm.  
 Dimensions: 3 m wide, 2 m high and 1 m deep at the bottom.  
 Colour: ● £ 60.00 per pair

## Weighting

- No. 1193 Chain weights** for indoor handball goal nets, 800 g per metre. Sheathed in plastic with a hook and tie cord at both ends. For nets with a depth of 1 m.  
 Length: 5 m £ 51.00 each



## Boundary Marking

- No. 1195 Boundary marking** for beach handball, 27 × 12 m, with reg'd design, adjustable plastic corner pieces and 50 mm wide polyester webbing strap. Same number of tapes as No. 1196-07. Complete with bungee elastic cords and sand anchor plates.  
 Colour: ● £ 117.00 each

- No. 1196 Boundary marking** for beach handball, 27 × 12 m, professional version, containing:  
 2 tapes of 27 m each for sidelines  
 4 tapes of 12 m each for goal touchlines made of 50 mm reinforced PP webbing  
 8 fibreglass reinforced plastic corner pieces, DGBM  
 8 sand anchor plates with bungee stretch cords  
 Colour: ● £ 138.00 per set

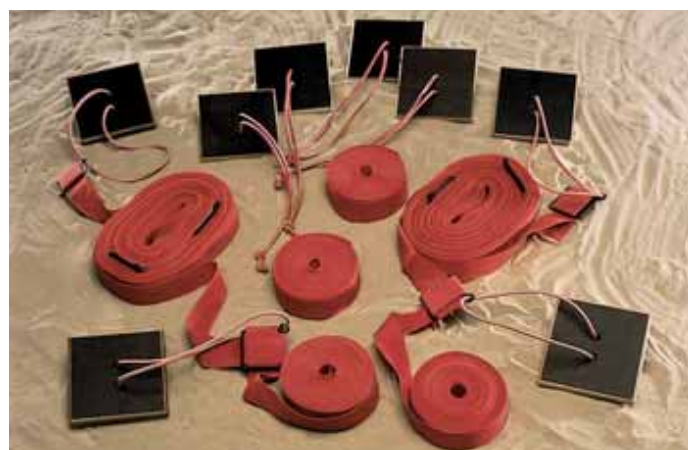
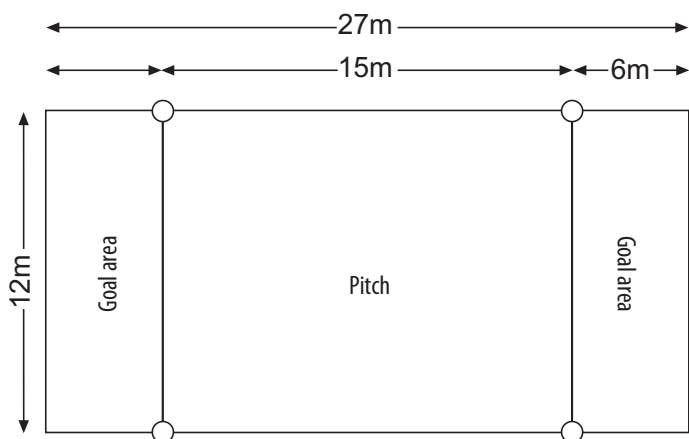

No. 1196-07

Prices excluding VAT



Beach-Soccer goal net with ballast chain in custom finish upon request

## Beach-Soccer

**No. 1519** **Knotless goal net** for beach soccer in approx. **4 mm high tenacity polypropylene**. Mesh size 120 mm.  
Dimensions: 5.70 × 2.25 m, top depth 0,80 m, bottom depth 1.50 m.  
Colour: ● £ 150.00 per pair

**No. 151** **Knotless goal net** for beach soccer in approx. **4 mm high tenacity polypropylene**.  
Dimensions: 5.15 × 2.05 m, top and bottom 1m.  
Colour: ● ● £ 72.00 per pair

**Goals are generally 5.50 m wide. When ordering beach soccer nets, please give the goal dimensions and goal depth.**

**No. 10175** **Ballast chain** for no. 1519 consisting of a chain 800 g/m, sheathed in plastic. Goal depth: 1.50 c  
**Length: 8.70 m** £ 89.00 each

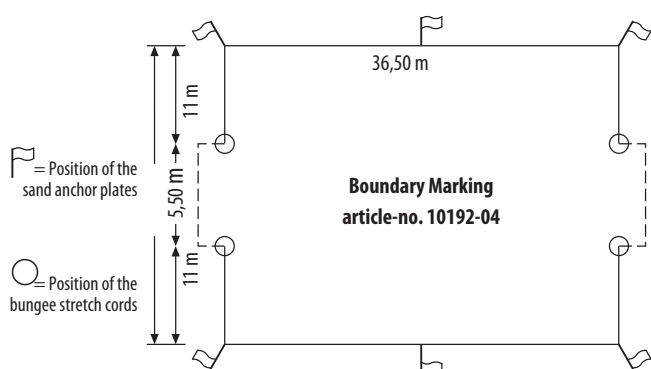

● = 01 = green      ● = 05 = yellow      ● = 09 = violet  
● = 04 = blue      ● = 07 = red

**Please quote the colour number when ordering!**

Prices excluding VAT

## Beach Soccer Boundary Marking

**No. 10192** **"International" pitch marking** for beach soccer, 36.50 × 27.50 m made from **100 mm wide blue webbing**, corners with **adjustable glass fibre-reinforced plastic pieces for 100 mm tape**, consisting of:

**2 × 36.5 m tapes** for sidelines, each with 11 m tapes for goal touchlines and corner pieces **already attached on either side** (both 36.50 m tapes have two 11 m tapes attached). These tapes each have an eyelet on one side for a rubber loop to attach them to a goal post. See illustration!

**4 rubber loops** for attaching side tapes to a goal post.

**6 sand anchor plates** with a bungee stretch cord for the 4 corners and the middle of the sidelines (the side band has an eyelet in the middle for attaching the sand anchor plates).  
Colour: ● £ 324.00 per set

**No. 10191** **"Competition" playing field marking** for beach soccer, 36.50 × 27.50 m, made of 100 mm wide blue webbing, with stitched corners and consisting of:

**2 tapes** of 36.50 m each for the sidelines

**2 tapes** of 27.50 m each for the goal touchlines

**4 sand anchor plates** with bungee stretch cords

Colour: ● £ 320.00 per set

The tapes are attached to each other at the corners to form **one** playing field with a total area measuring 36.50 × 27.50 m.



No 10192-04 (Detail: 1 tape with corner pieces, sand anchor plates and bungee cord)



## Goal nets for small playing areas and multi-sports facilities

For freely accessible multi-sports complexes in accordance with EN 15312 up to 3m in height there are the following mesh size restrictions:

- for **square** meshes the mesh size must not exceed 50 mm.
- for **diamond** meshes the mesh size must not exceed 100 mm

*Dimensions: width 3.10 m, height 2.10 m, top depth 80 cm, bottom depth 1 m.*

**No. 126** Small pitch goal net made of strong knotless approx. **5 mm high tenacity polypropylene**, with additional edging cord in the goal area. Mesh size: approx. 45 mm.  
Colour: ● £ 231.00 per pair

**No. 110** Small pitch goal net made of approx. **4 mm high tenacity polypropylene**, with additional edging cord in the goal area. Mesh size: approx. 45 mm.  
Colour: ● £ 170.00 per pair

*Dimensions: width 5.15, height 2.05 m, top depth 80 cm, bottom depth 150 cm.*

**No. 1545-045** Small pitch goal net made of approx. **4 mm high tenacity polypropylene**, with additional edging cord in the goal area. Mesh size: approx. 45 mm.  
Colour: ● £ 190.00 per pair

These goal nets have an additional cord in the goal area.

Where possible, these nets should not be pulled over the frame, but, where possible, they should be drawn tight with the elastic cord in the goal frame area.

Alternatively nets can be threaded onto the frame. In this case a diagram of the goal is needed to determine the right mesh size and dimensions!

**Football area nets with diamond mesh size see Page 10.4!**



Net with additional edging cord in the goal area





## Safety nets for small play areas and multi-sports facilities

For freely accessible multi-sports complexes in accordance with EN 15312 up to 3m in height there are the following mesh size restrictions:

- for **square** meshes the mesh size must not exceed 50 mm.
- for **diamond** meshes the mesh size must not exceed 100 mm

- No. 212-045** Safety net in approx. **5 mm high tenacity polypropylene**, knotless.  
 Mesh size: approx. 45 mm  
 Colour: ● ○ ● ● ● ● ● £ 7.00 per m<sup>2</sup>
- No. 212F045** Safety net in approx. **5 mm high tenacity polypropylene, in flame-retardant finish**.  
 Mesh size approx. 45 mm  
 Colour: ● ○ ● ● £ 9.00 per m<sup>2</sup>
- No. 214-045** Safety net in approx. **4.2 mm high tenacity polypropylene**, knotless.  
 Mesh size: approx. 45 mm  
 Colour: ● ● £ 7.00 per m<sup>2</sup>
- No. 209-045** Safety net in approx. **3 mm high tenacity polypropylene**, knotless.  
 Mesh size: approx. 45 mm  
 Colour: ● ○ ● ● ● ● ● £ 4.00 per m<sup>2</sup>



Urban-Volleyball-Court / Funtec.

## For hanging and tensioning

the nets, we recommend our steel cable with cable eye stiffeners and snap locks each side:

- No. 2097** Steel cable – **PVC-coated**, 5/7 mm thick  
 £ 1.00 per metre
- No. 2100** Steel cable – **zinc-coated**, 6 mm thick  
 £ 1.00 per metre
- No. 2101** Extra: cable eye stiffeners and snap locks each side.  
 For 6 mm wire £ 19.00 extra

**Surcharge for smaller nets:**  
 per single net

- nets under 5 m<sup>2</sup> + 100 %
- nets under 10 m<sup>2</sup> + 35 %
- nets under 20 m<sup>2</sup> + 20 %

- = 01 = green
- = 02 = white
- = 04 = blue
- = 05 = yellow
- = 06 = black
- = 07 = red
- = 08 = hemp coloured

Please quote the colour number when ordering!

## Street Basketball – the leader in Street Games

- No. 222**      **Basketball net in 3 mm polyethylene twine.**  
Colour: ○      £ 3.00 each
- No. 223**      **Basketball net in 3 mm nylon braid.**  
Colour: ○ ●      £ 2.00 each
- No. 227**      **Three-colour basketball net**  
made of approx. 4 mm polypropylene braid.  
Three-colour: ●●●      £ 4.00 each
- No. 4677-2**      **Basketball net, cut and tear resistant,**  
made of 5 mm Hercules rope (see Page 7.1).  
Colour: ●      £ 49.00 each



## All-weather net Particularly suitable for outdoor facilities

**Nets for ball sport facilities**, which cannot be replaced in winter or bad weather conditions, now **do not even need to be replaced.**

- No. 912**      **All-weather net** in coated polyester material, approx. 9.5 × 0.75 m, mesh width approx. 40 mm, **also possible to use as a multi-game net**, top band with approx. 11.7 m steel rope and a white PVC band along the top, fastening cords on all 4 corners.  
Colour: ●      £ 118.45 each



## Sun sail For sandpits, pools, etc.

Our **sun sails** are made of air and water permeable PE material and reduce solar radiation. They **prevent heat accumulation, build up of mildew and decay** and are long life.

- No. 722**      PE fabric, approx. 200 g/m<sup>2</sup>, hemmed, with loops spaced approx. every 0.5 m, with additional strengthening band.  
Colour: ●●○●●●●● on request

**Finishes possible in nearly all individual sizes and shapes**  
**You plan – we deliver according to your specifications!**

- |                      |                 |                     |
|----------------------|-----------------|---------------------|
| ● = 01 = green       | ● = 03 = orange | ● = 66 = silver     |
| ● = 015 = dark green | ● = 04 = blue   | ● = 76 = terracotta |
| ○ = 02 = white       | ● = 06 = black  | ● = 86 = cream      |

**Please quote the colour number when ordering!**





## Anti-Vandalism Nets

Who is not familiar with the problem of nets that are cut up or burnt down on public playgrounds and sports areas?

Of course, wire-mesh or metal fences can be used. However, these products absorb hardly any of the noise they produce and when played against with balls etc. generate a lot of noise that disturbs the whole neighbourhood.

Textile products are ideal for noise protection; steel or wire products are ideal for protection against vandalism.

In order to be able to offer products that satisfy both requirements, we have developed three different products that, depending on the thickness of the steel core, ensure different levels of protection against vandalism and noise.

Product	Thickness of steel core	Textile coating	Total thickness	Mesh stability	Vandalism protection	Noise protection
<b>Mahulan Steel</b> (high tenacity PP)	1.25 mm (wire strand)	3.5 mm	4.75 mm	approx. 2.5 kN	x (light)	xxx (strong)
<b>Clips-Net</b>	2.5 mm (steel wire)	2.5 mm	5 mm	approx. 0.5 kN	xx (medium)	xx (medium)
<b>Dralo®</b>	1.5–6 mm (steel wire)	without	1.5–6 mm	approx. 0.8–3.5 kN	xxx (strong)	xx (medium)

Thanks to their steel core or steel wire, all the products offer a better protection against vandalism than purely textile nets.

### "Mahulan Steel"

**A completely new product** from HUCK.  
A machine-made safety net with a stainless-steel core (wire strand)

(DBGM 20 2006 011 018) with the product name "Mahulan steel".

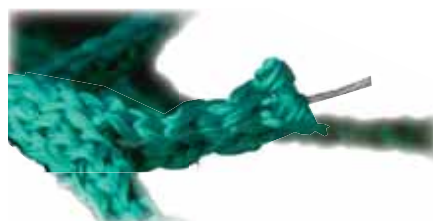

### Reinforced Textile Net

Steel wire coated with polyester (2.5/5 mm),  
**clipped together with plastic knot clips to form a square-mesh net**

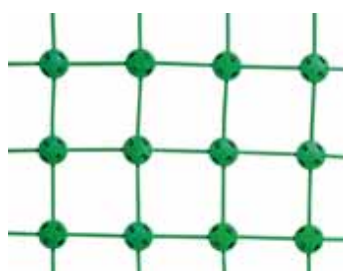

### Dralo®

**Dralo® the new wire rope net:**

- Discreet design
- Extreme force is required to damage it
- No rattling noise on contact with the ball





## Knotless antivandalism net "Mahulan steel" with stainless-steel, wire-strandcore

To the eye, this knotless net scarcely looks any different from our normal textile nets, but it has a stainless-steel, wire-strand core as vandalism protection and at the same time offers a high level of noise absorption. **The soft net with the hard centre.**

Mesh size: approx. 105 mm, square mesh  
(in 3 different standard widths)

Mesh size: approx. 60 mm, square mesh  
(in 2 different standard widths)

**No. 9830-105** "Mahulan steel" knotless stop net, approx. 1.25/4.75 mm high tenacity flame-retardant polypropylene.

Mesh size approx. 105 mm

**Fixed width of nets: 3 m**

Colour: ● £ 17.00 per m<sup>2</sup>

**No. 9840-105** "Mahulan steel" knotless stop net, approx. 1.25/4.75 mm high tenacity flame-retardant polypropylene.

Mesh size approx. 105 mm

**Fixed width of nets: 4 m**

Colour: ● £ 17.00 per m<sup>2</sup>

**No. 9820-105** "Mahulan steel" knotless stop net, approx. 1.25/4.75 mm high tenacity flame-retardant polypropylene.

Mesh size approx. 105 mm

**Fixed width of nets: 2 m**

Colour: ● £ 22.50 per m<sup>2</sup>

**No. 9830-060** "Mahulan steel" knotless stop net, approx. 1.25/4.75 mm high tenacity flame-retardant polypropylene.

Mesh size approx. 60 mm

**Fixed width of nets: 3 m**

Colour: ● £ 30.00 per m<sup>2</sup>

**No. 9840-060** "Mahulan steel" knotless stop net, approx. 1.25/4.75 mm high tenacity flame-retardant polypropylene.

Mesh size approx. 60 mm

**Fixed width of nets: 4 m**

Colour: ● £ 30.00 per m<sup>2</sup>

● = 015 = dark green

**When ordering, please specify which colour you require!**

### Surcharge for minimum quantities per single net:

nets under 5 m<sup>2</sup> + 100 %

nets under 10 m<sup>2</sup> + 35 %

nets under 20 m<sup>2</sup> + 20 %



### Mahulan Steel:

- Discreet design
- Extreme force is required to damage it
- No rattling noise on contact with the ball



## "Mahulan steel" knotless goal net with stainless-steel, wire-strand core

Dim.: width 7.50 m, height 2.50 m, top depth 0.80 m, bottom depth 1.50 m

- No. 996** "Mahulan steel" knotless goal net in flame-retardant **high tenacity polypropylene**. Material strength approx. 1.25/4.75 mm, mesh size approx. 100 mm, **square mesh layout**, including PA- coated tension cords (see drawing).  
Colour: ● £ 945.50 each

Dimensions: width 3 m, height 2 m, top depth 0.90 m, bottom depth 1.10 m

- No. 9964** "Mahulan steel" knotless goal net in flame-retardant **high tenacity polypropylene**. Material strength approx. 1.25/4.75 mm, mesh size approx. 100 mm, **square mesh layout**, including PA- coated tension cords (see drawing).  
Colour: ● £ 391.00 each

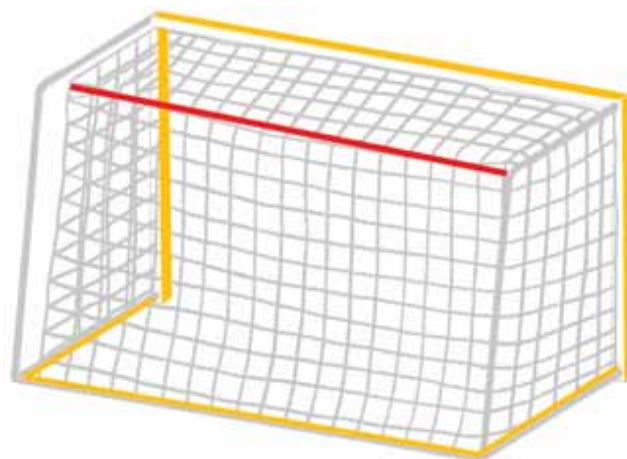

**Caution:** to ensure that they last a long time the goal nets should, in principle, be hung up only within the goal posts. The net should never be pulled over the frame.

## Replacement tension cords

- No. 46644** **Tension cord** made of encased (patent pending) steel cable, approx 3/4.5 mm thick, including 2 screw clips, one side with pressed-on loop. Length: 1 unit of 3.50 m (**coloured red for the rear upper goal depth**)  
£ 10.00 each

- No. 46645** **Tension cord** made of encased (patent pending) steel cable, approx 3/4.5 mm thick, including 2 screw clips. Length: 1 unit of 12.50 m (**coloured yellow for the goalmouth area and the lower end of the goal**)  
£ 30.00 each

**This cord enables the net to be fixed mesh by mesh to the floor area.**

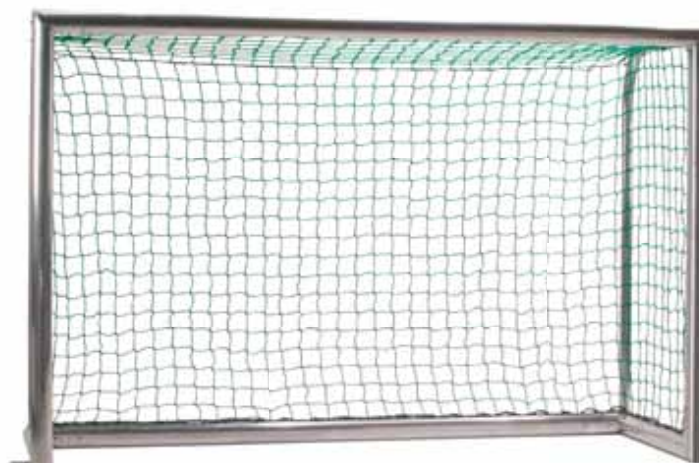

Main picture: practice pitch goal net no. 9964-01

Detail: additional tension cords

**Replacement tension cords for no. 996-01 on request!**



No. 4064



Anti-theft tension cord for assembly

## Dralo® Practice Pitch Goal Net

- No. 4064** **Dralo® practice pitch goal net** made of galvanised steel wire cables, approx. 3 mm thick.  
 Net size: 3 m wide, 2 m high,  
 0.90 m deep at the top and 1.10 m deep at the bottom.  
 Mesh size: approx. 10 cm, **square mesh**.  
 Includes anti-theft tension cord assembly set.  
 £ 950.00 each

## Practice Pitch Goal Net with steel wire

- No. 4664** **Practice pitch goal net in polyester with steel wire (reinforced textile net)**, approx. 2.5/5 mm dia. Suitable for handball goals that conform to DIN EN 749 with net frame.  
 Net size: 3 m wide, 2 m high, top and bottom depth 0.90 m.  
 Mesh size: 10 cm, **diagonal mesh**.  
 Colour: ● £ 526.00 each

**Caution:** to ensure that they last a long time the goal nets (no 4064 + 4664) should, in principle, be hung up only **within** the goal posts.  
 The net should never be pulled over the frame.

**Now considerably improved:** with additionally included protective tension cord made of encased (patent pending) steel cable, approx 4.5 mm thick, see also page 10.3.

**NEW: with additional scratch protection** around the edge made from high-quality polyamide loops (see small picture)

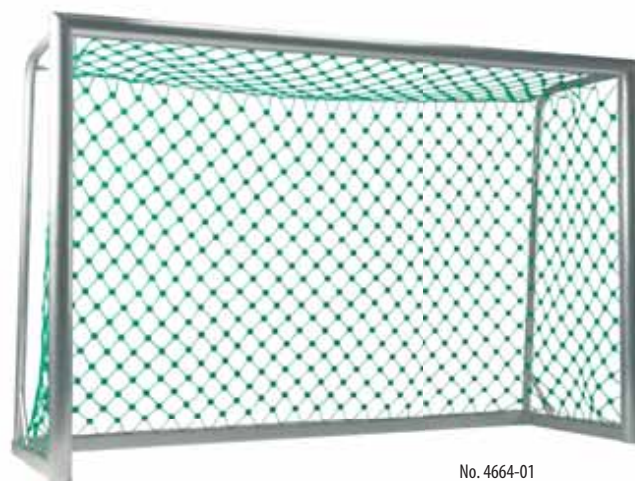

No. 4664-01



Scratch protection for no. 4664

## Practice Pitch Goal Net "Heavy Duty"

- No. 4764** **Very robust football net made from 9.6 mm polyethylene with new braided cord/braiding technology.** Net size: 3 m wide, 2 m high, 1 m deep top and bottom. Mesh size: 10 cm, **diagonal mesh**.  
 Colour: ● £ 375.00 each  
 (additional protective tensioning cords upon request)



No. 4674-06: Thickness of the material means high abrasion and cutting resistance.



No. 4674

## Reinforced Volleyball Nets

These nets can be used in a wide variety of ways and the HUCK system of knots is used to reinforce different mesh and net sizes for all types of sport.

**No. 4674** **Volleyball net equipment**, ready to install complete with beams, tensioning cords at the sides and volleyball net in polyester with steel core (reinforced textile net), approx. 2.5/5 mm dia., 1 m × 9.50 m, mesh size 100 mm  
Colour: ● £ 1,779.50 each

**No. 4674-1** **Volleyball net in polyester with steel core** (reinforced textile net), approx. 2.5/5 mm dia., 100 mm mesh. Dimensions per International standards: 1 m × 9.50 m.  
Colour: ● £ 1,384.00 each

Volleyball net system with steel posts available upon request!

## Dralo® Volleyball Nets

An attractive volleyball net that cannot be cut.

**No. 4074-1** **Volleyball net made of galvanised steel wire ropes (Dralo®)**, approx. 2 mm in diameter, with a mesh size of 100 mm. The net measures 1 m 9.50 m in accordance with international regulations. **For use with standard volleyball posts.** Tape, 160 mm wide, made of coated woven fabric and bearing the Huck logo.

£ 875.00 each

**No. 4074-2** **Volleyball net** as no. 4074-1, but **PA-coated steel rope 1.8/2.5 mm**, in green (see small picture).  
£ 945.00 each

See page 9.3 for boundary marking (item 555-04).

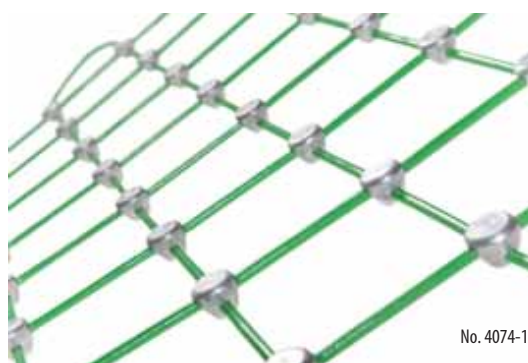

No. 4074-1



Further information about Dralo® can be found on page 10.7.



## Equipment for Neighbourhood Playgrounds as multi-functional games equipment in residential areas.

Multifunctional games equipment has an important social function in residential areas. **A place where the young can meet and unwind, on their own, or as a team**, without running the risk of breaking windows or urban property by accident.

**Equipping these facilities with anti-vandalism sports nets not only makes them extremely durable but also improves the quality of residential areas.**

**No. 4305-100 Safety & stop nets in polyester with steel wire (reinforced textile net)**, approx. 2.5/5 mm dia., 100 mm mesh.

Devised to partition fields or to stop balls behind goal posts.

Colour: ●

price on request



When used as a vandal-proof ball stop net, our Hercules net has better sound-absorbing properties than wire mesh netting or a steel-lattice fence.

The emission noise-pressure level was measured according to EN ISO 11202.

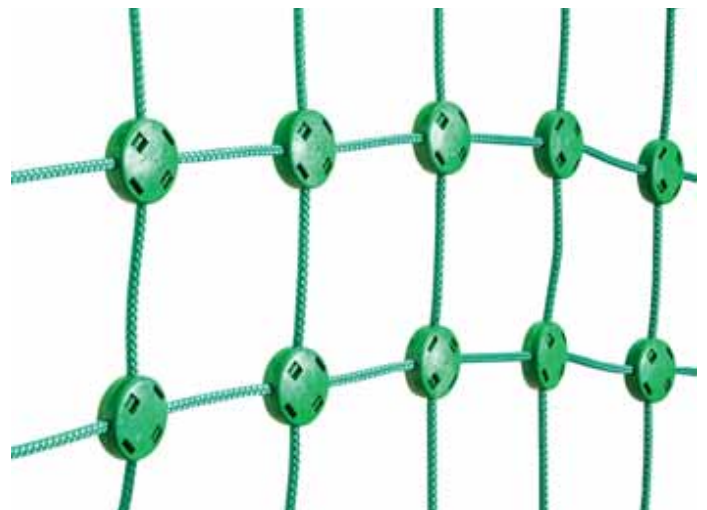





## Huck-DRALO®-ball stop modular fencing system

**NEW**

The Huck-Dralo® ball stop modular fencing system consists of a basic module that comes in a standard 5 m width and 5 m height. As many 5 m x 5 m module extensions as you wish can be added.

The basic module contains two posts, a net, plus a crossbar to finish it at the top, tension cables and assembly accessories. Each expansion module comes with an additional post, the net and all the small parts required.

**NEW**

The anchoring device has been specially developed for the system (above) and ensures a very light section profile with maximum stability. This straight finish is also very important to give the look of a wire rope net.

The net areas (net + crossbeam) can easily be assembled by one person on a mobile elevated platform. The system allows efficient assembly with long-lasting, vandal-proof components.

The differing mesh size design (50 x 100 mm at the bottom, 50 x 200 mm from 2 m up) prevents people from climbing up the fence and also means it weighs less. Under EN 15312 the horizontal mesh size of ball stop fencing should not exceed 50 mm to make climbing it harder.

No. 46500

**Huck-Dralo®-ball stop fencing – basic module**

Width: 5 m, height: 5 m

Price upon request

No. 46500-2

**Accessorie for 90°-corner module**

Price upon request

**NEW**

**NEW**

No. 46500-1

**Huck-Dralo®-ball stop fencing – extension module**

Width: 5 m, height: 5 m

Price upon request

**NEW**

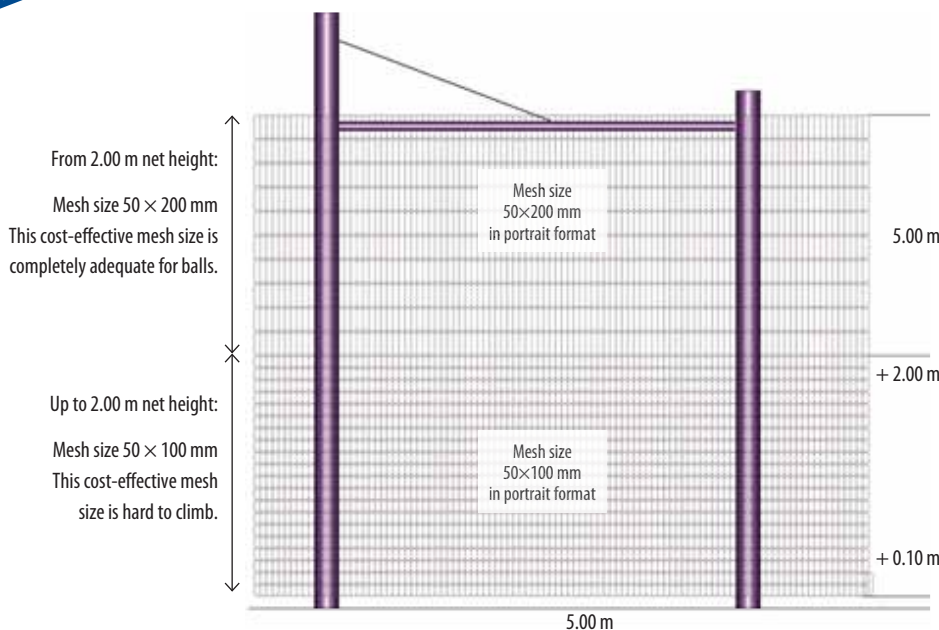

– **Quiet ball stop fencing:** due to fixed net knot connections

– **Vandal-proof:** thanks to steel cable net

– **Easy to assemble:** thanks to the handy module size



## Dralo® Anti-Vandalism Nets

Dralo anti-vandalism nets have a modern and attractive appearance. These mechanically produced wire rope nets have a square mesh. They are aesthetically pleasing in spite of their strength. These nets are supplied for use as practice pitch goal nets and safety nets (e.g. stop nets for balls).

**When ordering safety and stop nets, please specify whether you require the galvanised or stainless steel design.**

**Nets can be supplied with the following mesh sizes (MS)/rope diameters: Price on application**

	MS 25 mm	MS 50 mm	MS 75 mm	MS 100 mm	MS 125 mm	MS 150 mm	MS 175 mm	MS 200 mm
1,5 mm ø	×	×	×	×	×	×	×	×
2,0 mm ø	×	×	×	×	×	×	×	×
2,5 mm ø		×	×	×	×	×	×	×
3,0 mm ø		×	×	×	×	×	×	×
4,0 mm ø		×	×	×	×	×	×	×
5,0 mm ø			×	×	×	×	×	×

Prices, colours, mesh layouts and finishes on request!



Mesh layout: rectangular – on request

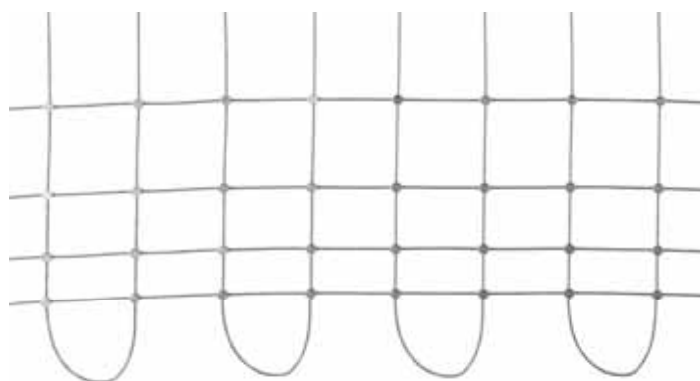

Mesh layout: various – on request

Prices excluding VAT

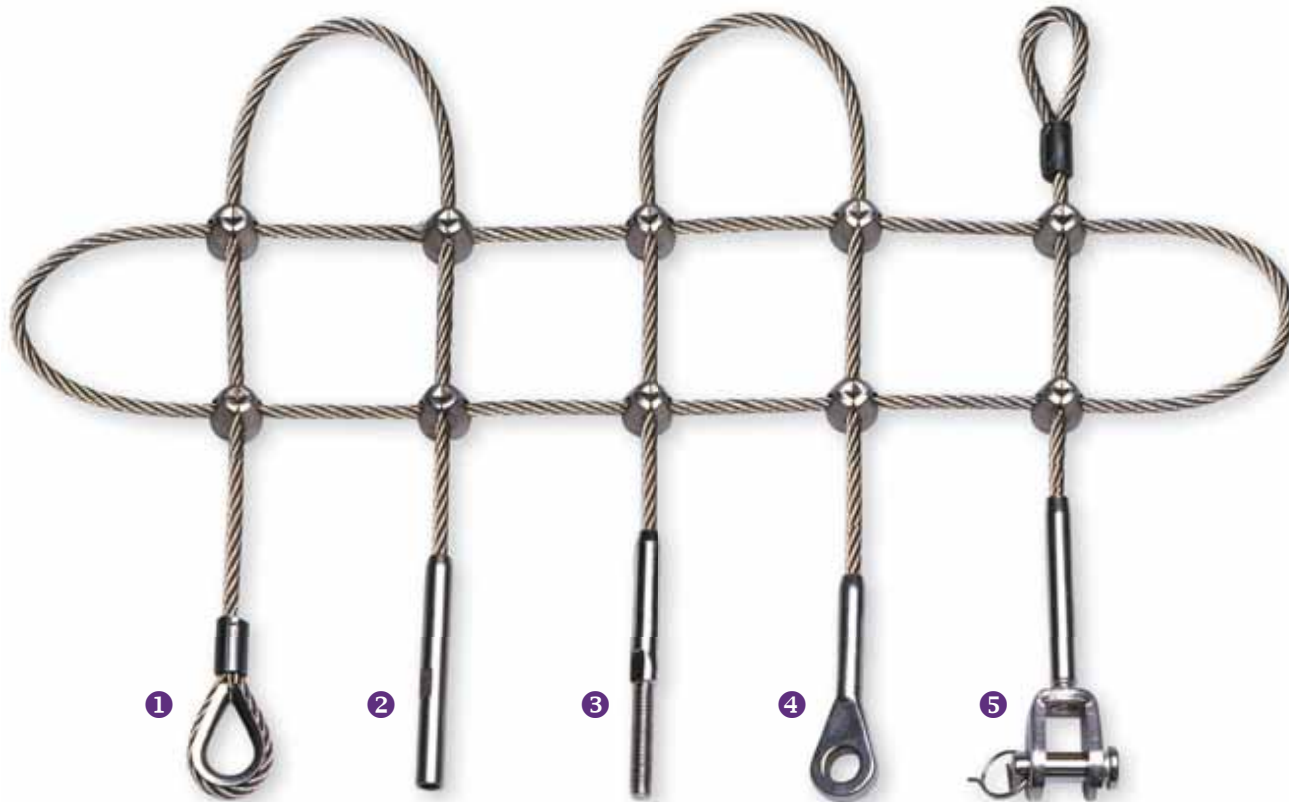

DRALO®-nets can be equipped with the following alternative fittings:

- 1 Looped eye
- 2 Female thread fitting
- 3 Thread fitting
- 4 Eye fitting
- 5 Forked fitting

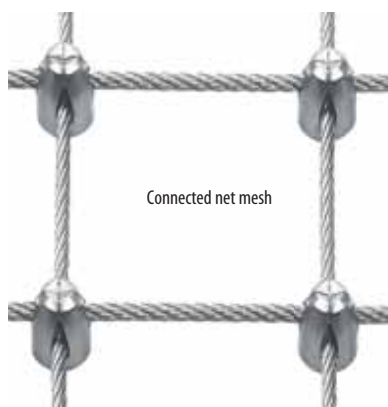

Connected net mesh

### Lateral displacement force where wires cross

Rope in mm	Aluminium clips on galvanised ropes	Aluminium clips on Nirosta ropes	Nirosta clips on Nirosta ropes
1,5 mm	80 kg	80 kg	90 kg
2,0 mm	100 kg	170 kg	170 kg
2,5 mm	110 kg	170 kg	170 kg
3,0 mm	150 kg	300 kg	250 kg
4,0 mm	200 kg	430 kg	330 kg
5,0 mm	300 kg	500 kg	350 kg
6,0 mm	400 kg	750 kg	360 kg
8,0 mm	900 kg	1200 kg	–

### Breaking strengths of wire ropes

Galvanised wire ropes			Stainless-steel wire ropes, material 1,4401		
Rope in mm	Constr.	Minimum-breaking strength	Rope in mm	Constr.	Minimum-breaking strength
1,5 mm	7 × 7	1,5 kN	1,5 mm	7 × 7	1,7 kN
2,0 mm	7 × 7	2,5 kN	2,0 mm	7 × 7	2,5 kN
2,5 mm	7 × 7	4,1 kN	2,5 mm	7 × 7	3,9 kN
3,0 mm	7 × 7	5,7 kN	3,0 mm	7 × 7	5,6 kN
4,0 mm	7 × 7	10,2 kN	4,0 mm	7 × 7	9,6 kN
5,0 mm	7 × 19	14,7 kN	5,0 mm	7 × 19	14,9 kN
6,0 mm	7 × 19	21,2 kN	6,0 mm	7 × 19	20,9 kN
8,0 mm	7 × 19	37,6 kN	8,0 mm	–	–

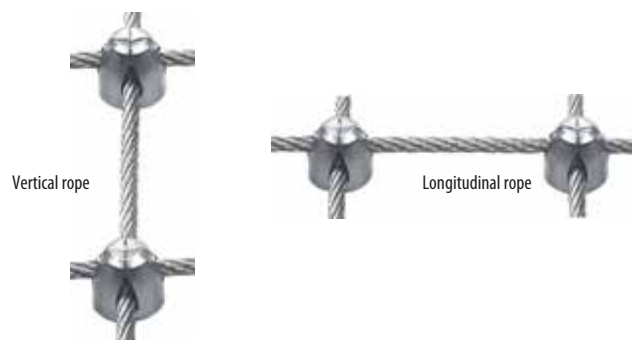

Prices excluding VAT

# Terms and conditions of sale

Extract from the Conditions of Sale of the Company – Full Conditions of Sale are available on request

## Prices

Every effort will be made to keep prices firm, but we reserve the right to vary with them without notice.

## VAT

Extra at rate ruling at time of invoice.

## Credit Surcharge

Sums which are overdue and have not been paid by the end of the month of the invoice, will be surcharged at the rate of 1.5 % (compound) per calendar month or part of calendar month thereafter.

## Title

Title to the goods does not pass to the purchaser until the account is settled in full. Risk passes to the purchaser on delivery.

## Quality

We use the most suitable materials for the intended purpose of the article. It is not our policy to vary quality but we reserve the right to use alternative materials when we consider it suitable or necessary. Weight of goal posts etc. listed are approximate.

## Carriage

A standard carriage charge of £12.00 will be added to all orders, except items marked "carriage extra", on these orders carriage will be charged at cost.

## Packing

Free, except any wood cases or specially requested materials which are charged at cost.

## Non-Delivery or Damage

If goods are not received within 10 days from date of invoice we must be notified immediately in writing, otherwise no responsibility can be accepted. Damage or Part Delivery must be advised within 3 day of receipt.

## Returns

No goods can be accepted for credit without written permission from the Company. A 15 % handling and restocking charge will be applied to all credit notes covering returned goods, plus carriage where applicable. Returns will only be accepted on goods received back in saleable condition. This condition does not apply where there is a justifiable complaint relating to the quality of the goods supplied.

## Guarantee: legal requirements apply.

Our nets are textile products with features that are damaged by exposure to UV radiation. The netting is therefore UV-stabilised although this only represents additional protection.

The guarantee only applies to the features of the net when new, which of course include the standard addition of UV stabilisers.

For this reason, the manufacturer's test regulations (test mesh) must be observed for nets that provide personal protection.

Notes:

---

---

---

---

## Technical Details

Item	Description	Colour	Diameter (mm)	Mesh size (mm)	Weight g/m <sup>2</sup>	Burst strength (kN)
200-020	Polypropylene, high tenacity, knotless	● ● ○ ● ●	2.3	20	180	0.80
200-025	Polypropylene, high tenacity, knotless	●	2.3	25	145	0.80
200-030	Polypropylene, high tenacity, knotless	○ ●	2.3	30	135	0.80
200-045	Polypropylene, high tenacity, knotless	● ● ○ ● ●	2.3	45	90	0.80
200-100	Polypropylene, high tenacity, knotless	● ○ ●	2.3	100	50	0.80
200-120	Polypropylene, high tenacity, knotless	● ● ○	2.3	120	35	0.80
201-020	Polypropylene, high tenacity, knotless	○ ●	1.8	20	130	0.60
201-025	Polypropylene, high tenacity, knotless	● ●	1.8	25	100	0.60
201-030	Polypropylene, high tenacity, knotless	●	1.8	30	85	0.60
1202-020	Polypropylene, high tenacity, knotless	○ ● ●	1.0	20	50	0.20
1202-030	Polypropylene, high tenacity, knotless	○ ● ●	1.0	30	30	0.20
1202-050	Polypropylene, high tenacity, knotless	○ ● ●	1.0	50	20	0.20
1203-010	Polypropylene, high tenacity, knotless	● (diagonal)	1.5	10	150	0.25
203-020	Polypropylene, high tenacity, knotless	●	1.5	20	80	0.25
203-028	Polypropylene, high tenacity, knotless	●	1.5	28	44	0.25
203-030	Polypropylene, high tenacity, knotless	○ ●	1.5	30	50	0.25
203-050	Polypropylene, high tenacity, knotless	●	1.5	50	35	0.25
203-060	Polypropylene, high tenacity, knotless	●	1.5	60	30	0.25
203-100	Polypropylene, high tenacity, knotless	●	1,5	100	15	0.25
204F008	Polypropylene, high tenacity, knotless	● (hexagonal)	1.8	8	260	0.27
205-100	Polypropylene, high tenacity, knotless	●	2.8	100	60	1.00
205-120	Polypropylene, high tenacity, knotless	●	2.8	120	50	1.00
207-045	Polypropylene, high tenacity, knotless	● ●	3.5	45	200	1.40
207-100	Polypropylene, high tenacity, knotless	● ●	3.5	100	100	1.40
207-120	Polypropylene, high tenacity, knotless	● ●	3,5	120	70	1.40
209-030	Polypropylene, high tenacity, knotless	●	3.0	30	260	1.10
209-045	Polypropylene, high tenacity, knotless	● ○ ● ● ● ● ● ●	3.0	45	148	1.10
209-100	Polypropylene, high tenacity, knotless	● ○ ● ●	3,0	100	75	1.10
209-120	Polypropylene, high tenacity, knotless	● ○ ● ●	3.0	120	65	1.10
210-035	Polyester, knotless	○	4.0	35	350	2.00
210-045	Polyester, knotless	○	4.0	45	285	2.00
210-100	Polyester, knotless	○	4.0	100	150	2.00
210-130	Polyester, knotless	○	4.0	130	100	2.00
212-030	Polypropylene, high tenacity, knotless	●	5.0	30	490	3.20
212-045	Polypropylene, high tenacity, knotless	● ○ ● ● ● ● ●	5.0	45	400	3.20
212-050	Polypropylene, high tenacity, knotless	○	5.0	50	350	3.20
212-060	Polypropylene, high tenacity, knotless	● ● ● ●	5.0	60	300	3.20
212-070	Polypropylene, high tenacity, knotless	●	5,0	70	275	3.20
212-100	Polypropylene, high tenacity, knotless	● ○ ● ● ● ● ● ● ●	5.0	100	200	3.20
212-120	Polypropylene, high tenacity, knotless	● ○	5.0	120	170	3.20
213-100	Polypropylene, high tenacity, knotless	○	6.0	100	360	4.20
214-045	Polypropylene, high tenacity, knotless	●	4.2	45	230	1.80
215-030	Polypropylene, high tenacity, knotless	● ●	4.0	30	330	1.60
215-045	Polypropylene, high tenacity, knotless	● ○ ● ● ● ● ●	4.0	45	210	1.60
215-100	Polypropylene, high tenacity, knotless	● ○ ● ● ● ● ●	4.0	100	110	1.60
215-120	Polypropylene, high tenacity, knotless	● ○ ● ● ● ● ●	4,0	120	90	1.60
216-035	Polyester, knotless	○	3.0	35	230	1.25
216-045	Polyester, knotless	○	3.0	45	185	1.25
216-100	Polyester, knotless	○	3.0	100	90	1.25
216-130	Polyester, knotless	○	3.0	130	70	1.25
PL210-120	PLA (polylactic acid)	○	4.0	120	130	1.00

## Here are more top products from HUCK:



### Leisure sector: Huck rope technology

We have extended our playground range again this year. Products in this range, including climbing nets, swings, net bridges, rope ladders, climbing ropes and net playgrounds, can be found in our catalogue "Huck Rope Technology".

Please order this specialist catalogue.

### Industrial sector: Industrial Nets – for all applications

Lifting, tying, loading, covering, protecting, securing – a world of technology needs a world of nets. Few materials meet the diverse requirements of the industrial sector with the same variety or as economically as net.

Please order our specialist catalogue!



### Construction sector: Huck construction safety nets

for all needs You can find details of the nets required on building sites in our specialist safety net catalogue for the construction industry. Collection nets, brick guard rail nets and full information about our assembly service and rental of collection nets.

Just ask for a copy of our catalogue.

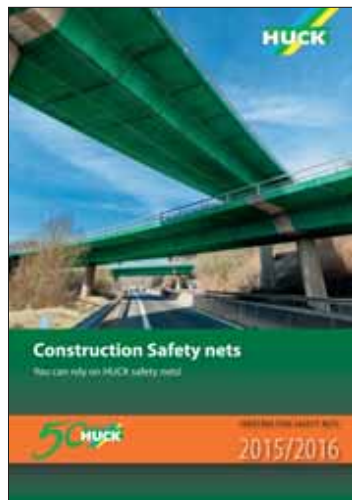

## HUCK NETS (U.K.) LTD. • Netting & Rope Factory

Gore Cross Business Park, Corbin Way, Bradpole, Bridport, Dorset DT6 3UX England

Telephone (0 1308) 425 100, Fax (0 1308) 458 109

E-Mail: [sports@hucknetting.co.uk](mailto:sports@hucknetting.co.uk)

Internet: [www.huck-net.co.uk](http://www.huck-net.co.uk)

Page	Item	Page	Item	Page	Item
<b>5.10</b>	<b>Advertising (printed)</b>	2.8	Floorball	6.1 - 6.4	Product information, safety nets
	<b>on tennis court surrounds</b>	1.13 + 1.14	Football accessories	7.10	Protective nets for squash courts
9.15	All-weather net	1.1 - 1.6	Football goal nets	5.5	Pull cords
3.6 + 9.4	Antennae support pockets	1.5	Football goal nets exclusive	<b>2.8</b>	<b>Roller hockey goal nets</b>
10.1 - 10.9	Anti-vandalism nets	1.12	Futsal goal nets	8.6	Rope plate
10.5	Anti-vandalism volleyball nets	<b>7.9</b>	<b>Golf practice net</b>	<b>6.5 - 6.6</b>	<b>Safety and stop net accessories</b>
7.1	Anti-whip basketball net	7.9	Golf ranges/courses ball safety nets	1.13	Shooting target wall
7.10	Archery protection nets	5.4	Ground anchor	4.3	Shuttlecock catch nets for badminton
<b>9.7 - 9.8</b>	<b>Badminton (leisure) accessories</b>	8.8	Gymnastic laces	3.5	Sit volleyball nets
4.2	Badminton net sets	8.7	Gymnastic ring set	8.8	Sitball bands
4.1	Badminton tournament nets	8.2 - 8.4	Gymnastic ropes	9.13 + 9.14	Small play areas (nets)
4.3	Badminton training nets	<b>7.5 + 7.6</b>	<b>Hammer safety nets</b>	1.5 + 1.9	Small-mesh football goal nets
1.13	Ball carrier nets	7.11	Hammocks	9.7 + 9.7	Soccer-Tennis net
1.14	Ballast chains/football	2.1 - 2.6	Handball goal nets + two-colour nets	7.2	Spectator safety nets
7.8	Baseball control nets	<b>7.2</b>	<b>Ice hockey goal nets</b>	6.5	Standard stop nets
7.1 + 9.15	Basketball nets	7.3	Indiaca nets	9.15	Street & fun games nets
9.6	Beach badminton	6.7	Indoor football stop nets	9.15	Sun sail
9.11	Beach handball	2.7	Indoor hockey goal nets	8.2 + 8.4	Swing ropes
9.12	Beach soccer	8.1	Isilink lines	<b>5.5</b>	<b>Tennis court drag nets</b>
9.9 + 9.10	Beach tennis	<b>8.2 - 8.4</b>	<b>Jump ropes</b>	5.9	Tennis court surrounds
9.1	Beach volleyball tournament nets	1.7 - 1.10	Junior football goal nets	5.9	Tennis court surrounds
9.2	Beach volleyball training nets	9.8	Junior lawn tennis nets	5.4	Tennis net accessories
9.10	Beach-KOMBI-set	5.6 + 9.10	Junior tennis nets	5.1 - 5.3	Tennis nets
8.4	Beaded jump ropes	7.4	Landing pit cover	2.4	Tension cords for handball nets
9.4, 9.11 - 9.12	Boundary marking	3.3	Long volleyball nets	4.3	Tensioner for badminton
<b>2.6</b>	<b>Catch nets for indoor handball goals</b>	8.7	Lunge reins	3.6	Tensioner for volleyball
2.6	Chain weights/handball	<b>10.1 - 10.3</b>	<b>Mahulan steel</b>	8.5	Tug of war rope
8.5	Circular rope	1.11	Mini goal nets	1.1, 1.6 - 1.7,	Two-colour football goal nets in club colours
8.6	Climbing ropes	9.13 + 9.14	Multi-sports facilities (nets)	1.10	
7.7	Cricket safety and stop nets	<b>8.4</b>	<b>Neon ropes</b>	<b>1.14</b>	<b>Velcro strips</b>
7.3	Cycle ball / cycle polo goal nets	7.12	Net climbing course	3.5 + 9.3	Volleyball antennae
<b>7.3</b>	<b>Deck tennis nets</b>	5.8, 6.8 + 6.10	Nets with flame-retardant finish	3.6 + 9.3	Volleyball net bag / net frame
7.5	Discus safety nets	10.1 - 10.9	Nets with steel core	3.1 - 3.3	Volleyball tournament nets
5.7 + 5.8	Dividing nets	<b>6.8</b>	<b>Partition curtains for gymnasiums</b>	3.1 - 3.2	Volleyball tournament nets – DVV I standard
8.4	Double Dutch skipping ropes		Pendulum ball cords	3.2	Volleyball tournament nets – DVV II standard
10.7 - 10.9	Dralo steel wire-rope nets	8.8	Play area safety net	3.4	Volleyball training nets
<b>1.14</b>	<b>Fastening net ties</b>	6.9	Practice pitch goal nets	<b>7.3</b>	<b>Water polo goal nets</b>
2.8	Field hockey goal nets	10.4	Prellball band		
8.8	Fistball ropes/tapes	8.8			

## Head Office Germany:

**Manfred Huck GmbH**, Asslarer Weg 13–15 · D - 35614 ABlar-Berghausen-Germany · Tel. + 49 64 43 630 · Fax + 49 64 43 6330

## International Huck-Branches & Joint Sales Offices:

**Benelux: Huck N.V.**, Atlasstraat 2 · B - 8680 Koekelare-Belgium · Tel. + 32 51 58 23 20 · Fax + 32 51 58 20 55

**Netherlands: Huck Torimex BV**, Kalkbranderstraat 5 · NL - 2222 BH Katwijk ZH-Netherlands · Tel. + 31 71 409 77 00 · Fax + 31 71 409 77 01

**Austria: Berger GmbH**, Industriestraße 9 · A - 2000 Stockerau-Austria · Tel. + 43 22 66 6 21 26-0 · Fax + 43 22 66 6 21 26-27

**France: Huck Occitania S.A.**, Les Clauzollès · F - 81 470 Maurens Scopont-France · Tel. + 33 563 82 51 31 · Fax + 33 563 82 51 36

**Czech Republic: Berger-Huck s.r.o.**, Vanišova 552 · CZ - 533 74 Horní Jelení-Czech Republic · Tel. + 420 466 67 33 06 · Fax + 420 466 67 33 05

**Poland: Huck Polska Sp.z o.o.**, ul. Obornicka 78 · PL - 51-114 Wrocław-Poland · Tel. + 48 71 32 57 550 · Fax + 48 71 32 53 422