

A Assembly instructions Adventure Bridge Crawl Tunnel Art. No. 4959-80

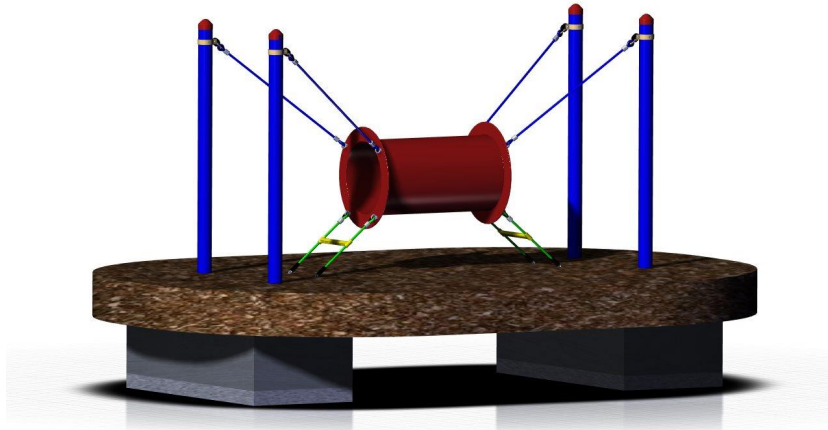

Operator: _____

Location: _____

Attention!

The distance between the center of the poles is 3.00 x 1.00m.

In case of an eventual add-on of any other rope-parcours elements (e.g. "Haiger", "Dillenburg", "Fun Parcours", etc.) the different distance between the poles has to be considered!

Revision history

Revision 0 – 2017- 04--25

The first released version

Assembly instructions JF

All rights reserved

© Copyright 2017 Huck Seiltechnik GmbH

Contents

A	Assembly instructions Adventure Bridge Crawl Tunnel Art. No. 4959-80	1
1	Introduction Assembling	4
2	Datasheet Adventure bridge “Crawl Tunnel”, article 4959-80	6
3	Delivery contents (parts list with part numbers).....	8
4	Erection instructions.....	10
5	Post installation checks.....	14
B	Maintenance instructions Adventure Bridge Crawl Tunnel, Art.-No. 4959-80	15
6	Introduction Maintenance	17
7	General maintenance information	18
8	Maintenance timetable	20
9	Regular maintenance	21
10	Monthly maintenance	22
11	Quarterly maintenance.....	22
12	Half yearly maintenance.....	22
13	Annual maintenance.....	23
14	Maintenance printout	25
15	Hand over document	27

List of Tables

Table 3-1: Delivery contents, in words	8
Table 3-2: Delivery contents, in symbols	9

1 Introduction Assembling

1.1 General information

This equipment should be installed, inspected, maintained and operated in accordance with EN1176-7 guidelines.

Before installation work commences, please check that you have all of the equipment and fixation components in the parts list provided (see Tables 3-1 and 3-2).

Please consider that the installation has to be carried out only on even terrain (max.slope up to 3%).

Any spare parts that may be required can be obtained directly from your supplier.

Please do not hesitate to call your supplier if you have any problems during installation or in case of any other questions.



Following installation, complete assembly instructions, maintenance instructions and maintenance record must be sent to the operator who must confirm receipt in writing. See the last page of this document.



All nuts and bolts are hot-dip galvanised or stainless steel.

One of the characteristics of stainless steel is that uncontrolled cold welding may occur when the nuts are tightened. To prevent this, it is necessary to spray the nuts and bolts with Teflon spray or another similar lubricant.

We hereby confirm that this play equipment has been tested and certified in accordance with the play equipment standard EN 1176.

Drawings / Views

All optical drawings are showing only the measurements/dimensions and are no mandatory technical views of the complete item.

We reserve the right to change technical details of our articles which are serving for the further development of our articles and are reasonable for the customer.

Measurement tolerances

Because of the properties and characteristics of the components, minor measurement tolerances compared to the indication on the sketches are possible.

This concerns all shown measurements except the foundation measurements resp. measurements below upper edge ground level/play area.

2 Datasheet Adventure bridge “Crawl Tunnel”, article 4959-80

- Space requirement: 3.80 x 1.80 m and/or 4,72 m x 3,38 m including safety zone,
height of fall 1.0 m

The images (individual drawings) are not to scale!!

- Required safety surface:

Surface material	Description mm	Minimum thickness of layer mm	Maximum height of fall mm
Topsoil grass			<= 1000*
Chipped bark	20 – 80 grain size	300/400	<= 2000/3000
Wood chippings	5 – 30 grain size	300/400	<= 2000/3000
Sand	0.2 – 2 grain size	300/400	<= 2000/3000
Gravel	2 – 8 grain size	300/400	<= 2000/3000
Other ground materials	As recommended by manufacturer		

- Name and overall dimension of the largest component:
4 steel posts length 2.00 m, ø 102 mm
- Name and weight of the heaviest component:
4 Steel posts 92 kg
- Intended age group: 2 years and over
- Please note that this equipment is set in concrete.**
Concrete: C25/30=1,3 m³
Foundations/area to be excavated:
2 x 1.80 m long x 0.80 m wide, total depth 0.80 m including 10 cm drainage
Top edge of concrete rounded



Attention!

Round off foundation edges (min.R = 100 mm)! Sizes of foundations are “4-5” (natural ground).

Soil class 4: soft to medium plasticity, interleave bound, with minor portion of stone (portion < 30% with bigger diameter of 63 mm grain size).

Soil class 5 : ground with soil class 3 and 4 with big portion of stones (portion > 30% with bigger diameter of 63 mm grain size).

In case of sandy and soft soils, the surface measure of foundations have to be enlarged for about 50%!

7. Assembly time, once foundations completed: approx. 30 minutes.
Required assistants: 2 people.
8. Any spare parts which may be required can be obtained directly from your supplier
9. **We hereby confirm that this item of play equipment has been tested and certified in accordance with the play equipment standard EN 1176.**

3 Delivery contents (parts list with part numbers)







3.1 In words

Table 3-1: Delivery contents, in words

Pos.	Quantity	Element / Description	Size	O.K.	Missing
1	4	Steel posts	Ø 102 mm, 2.00 m long		
2	4	Pipe clamps with M12 x 150 mm bolts + 2 nuts	For Ø 102		
3	4	Pipe clamps with carriage bolt and nyloc nut	For Ø 102		
4	4	Post caps	For Ø 102		
5	12	Self-tapping screws	5,5 x 25mm		
6	4	Anker-eye bolt + 2 nuts	M12 x 150 mm		
7	4	Shackle	8mm		
8	2	Paint + brush			
9	1	Crawl Tunnel			

3.2 In symbols

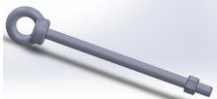
Table 3-2: Delivery contents, in symbols

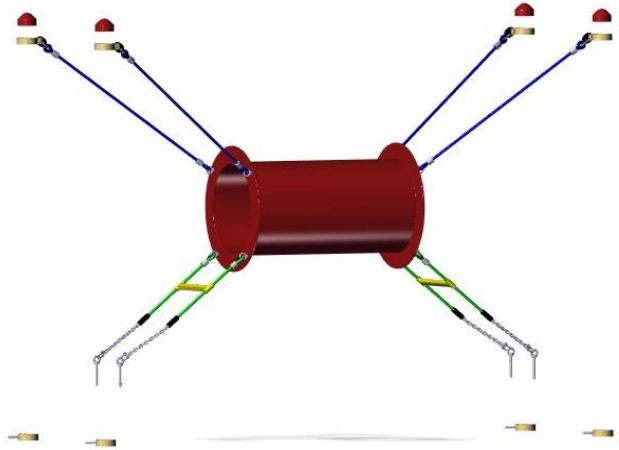
Pos.	Quantity	Symbol
1	4	 <p>Ø 102 mm, 2.00 m long</p>
2	4	
3	4	
4	4	
5	12	
6	1	
7	4	
8	1	
9	1	

4 Erection instructions

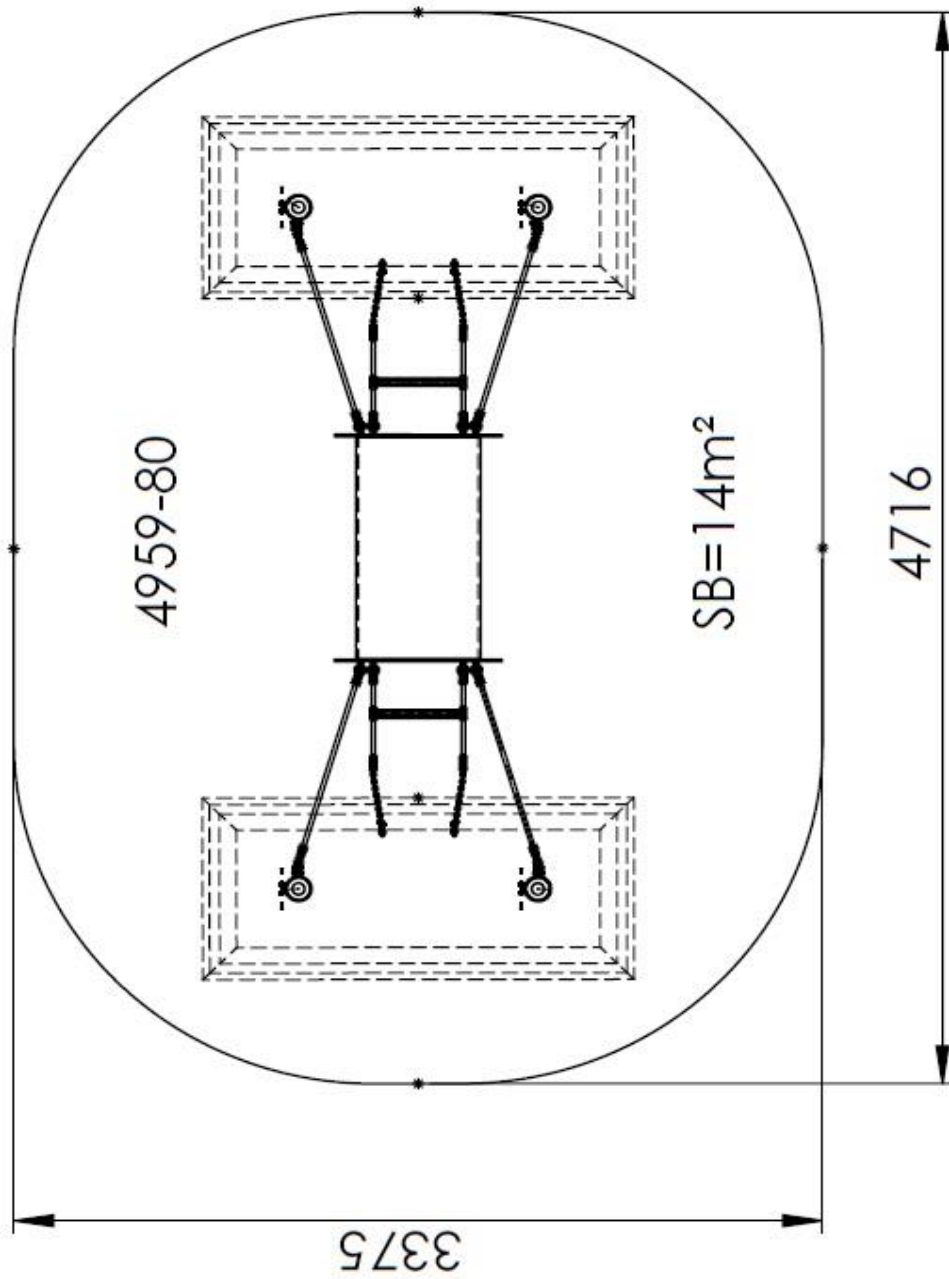

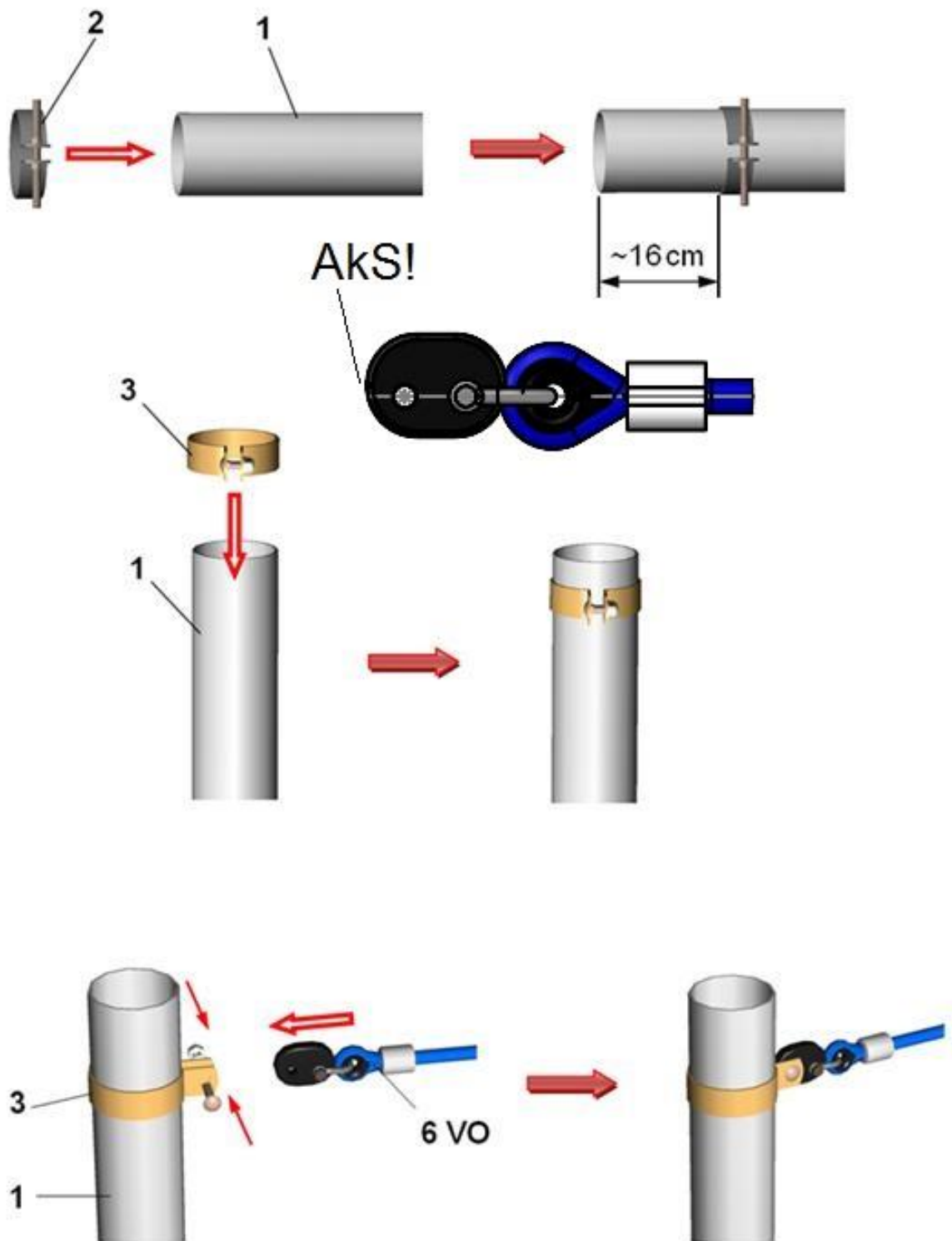

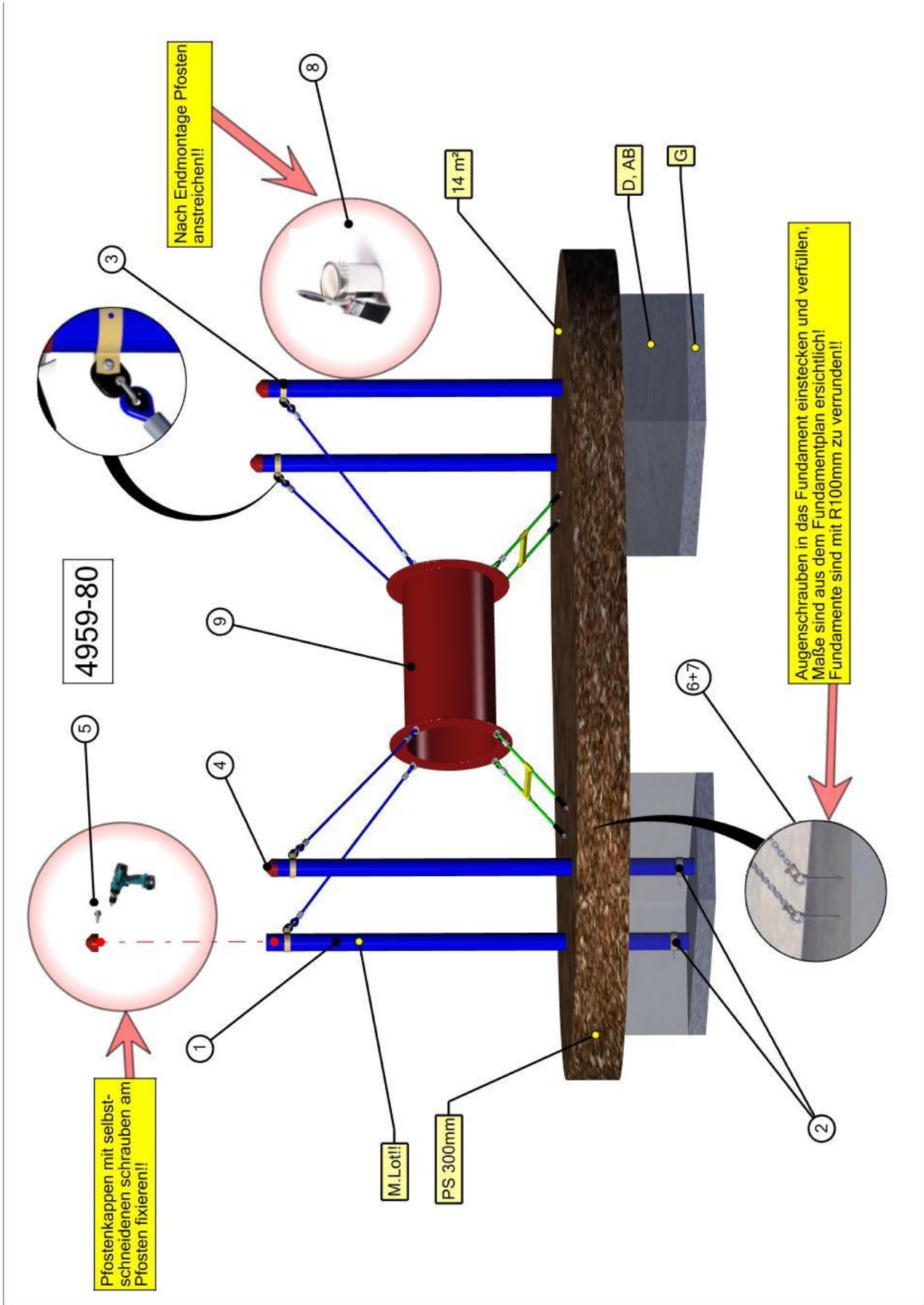

AB	Setting time for C25/30 concrete at least 7-8 days
Dt	Detail
D	C25/30 concrete (for foundations
F	Fall protection
FR	Round off the upper edges of foundations at least 10 cm
G	Drainage layer 10 cm
O.K	Upper edge of playing level
Gehw. PI.	Paving slab e.g. access boards supplied on-site by the client – to be laid below the posts! Upper drainage level (see drawing).
P	Post
VO	Prefitted
AkS	
M.Lot!	Install posts vertically level
 Attention!	<p>Round off foundation edges (min.R = 100 mm)! Sizes of foundations are “4-5” (natural ground).</p> <p>Soil class 4: soft to medium plasticity, interleave bound, with minor portion of stone (portion < 30% with bigger diameter of 63 mm grain size).</p> <p>Soil class 5 : ground with soil class 3 and 4 with big portion of stones (portion > 30% with bigger diameter of 63 mm grain size).</p> <p>In case of sandy and soft soils, the surface measure of foundations have to be enlarged for about 50%!</p>
PS	Space requirement including safety zone

See drawings for details of shortcuts

5 Post installation checks



If the equipment has not been installed safely, you must ensure that the public is prevented from using it.

5.1 Marking filler depth

- Labelling the posts to show the depth of material provided as fall protection (i.e. loose filler).

5.2 The equipment has not been installed safely in the following cases:

- Installation of equipment is not complete.
- The protective surface has not been installed.
- Appropriate maintenance work cannot guarantee operational safety.

5.3 Removal of all assembly aids

- Please make sure that all assembly aids have been removed from the playing area. The equipment must not be approved for use until this check has been carried out.

5.4 Information about inspection of the equipment before first use

- No special inspection required.

5.5 Retighten bolts

- After one week of operation, please retighten all bolts again. Later upon respective maintenance.

B Maintenance instructions Adventure Bridge Crawl Tunnel, Art.-No. 4959-80

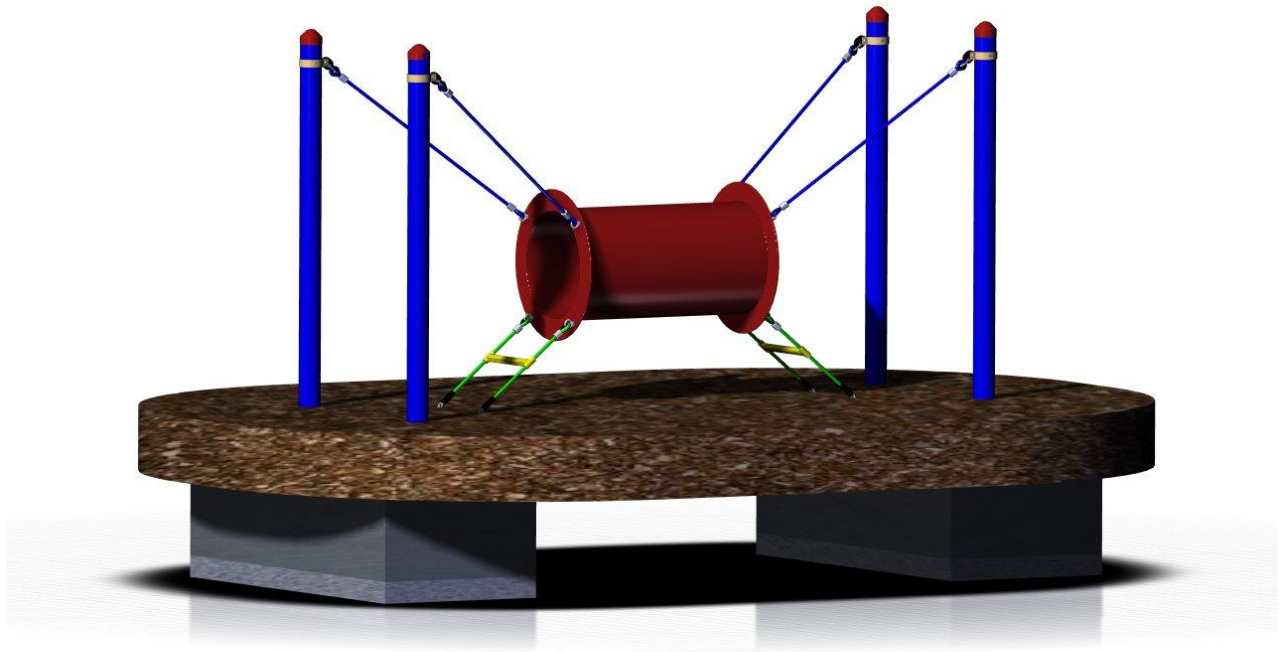

Revision history

Revision 0 – 2017-04-25

The first released version

Maintenance instructions

All rights reserved

© Copyright 2017 Huck Seiltechnik GmbH

6 Introduction Maintenance

6.1 General informations

This equipment should be installed, inspected, maintained and operated in accordance with EN 1176-7 guidelines.



Please note: Providing any necessary repairs are carried out, a piece of play equipment that is inspected regularly cannot become so damaged that it is dangerous.

Any spare parts which may be required can be obtained directly from your supplier.



This equipment should only be assembled, maintained and repaired by **persons with the necessary expertise**.

A copy of the inspection record should be given to the operator, who must confirm receipt.

**This maintenance instruction is based on the standard
“EN 1176-1:2008”.**

7 General maintenance information

7.1 Maintenance intervals

Maintenance intervals are based on average use. Please note that more frequent inspections and/or maintenance are required if the play equipment is subject to intensive use.

7.2 Inspection frequency

The frequency of inspections must be based on actual use. Factors that affect frequency include vandalism, location (e.g. coastal proximity), air pollution and the age of the equipment.

7.3 Maintenance products and procedures

All nuts and bolts are hot-dip galvanised or stainless steel. One of the characteristics of stainless steel is that uncontrolled cold welding may occur when the nuts are tightened. To prevent this, it is necessary to spray the nuts and bolts with Teflon spray or another similar lubricant.

7.4 Spare parts

All spare parts must conform to the manufacturer's specifications.

7.5 Identifying spare parts

All spare parts are listed in the parts list. The parts list follows the installation requirements.

7.6 Special instructions for the disposal of individual equipment components

No special instructions are necessary.

7.7 Special measures during the break-in period

No later than 2 weeks after assembly, all screwed connections should be checked and tightened if necessary.

7.8 Drainage holes

All drainage holes should be kept clear.

7.9 Maintenance of protective surfaces

Surfaces providing fall protection must also be maintained regularly. It is particularly important to maintain the correct level of loose surface material and add more if necessary.

7.10 Faults



Demages must be repaired as soon as they are detected. If serious defects that affect the safety cannot be repaired straight away, the playground item must be blocked with immediate effect.

7.11 Loose screws



Loose screws always cause quality problems and put safety at risk. Therefore, loose screws should always be tightened and checks carried out to ensure that there are no missing screws.

7.12 Preventing equipment use

The use of the equipment should be prevented in case of incomplete installation, disassembly, maintenance, repairs and faults.

7.13 Safeguarding the guarantee

Steel posts and footings are covered by our guarantee if regular maintenance is carried out and recorded in writing.

Our general terms and conditions apply. Maintenance of steel poles first takes place after 3 years. The steel posts must be excavated down to the concrete foundations and checked for corrosion.

Zinc paint should be applied to any corroded areas and scratches.

Check ropes for abrasion, replace ropes where coating is damaged down to the steel inlet.

8 Maintenance timetable

8.1 Special advices

8.1.1 Maintenance interval

We strongly advise you to carry out inspections and maintenance work within the specified periods as use of the equipment, the weather and malicious vandalism cause wear and tear that compromises the safety and function of the equipment.

8.1.2 Maintenance intervals in the event of intensive use

Please note that more frequent inspections and/or maintenance are required if the play equipment is subject to intensive use.

8.1.3 Faults that compromise safety



In the event of a fault that compromises safety, quick action must be taken. This may involve repairing it immediately or shutting down and dismantling the equipment.

8.1.4 Faults that compromise function



Faults that compromise function should also be repaired immediately. Such faults lower the value of the equipment to the user and encourage malicious vandalism, which may render the equipment less safe. Any damage should also be repaired immediately.

9 Regular maintenance

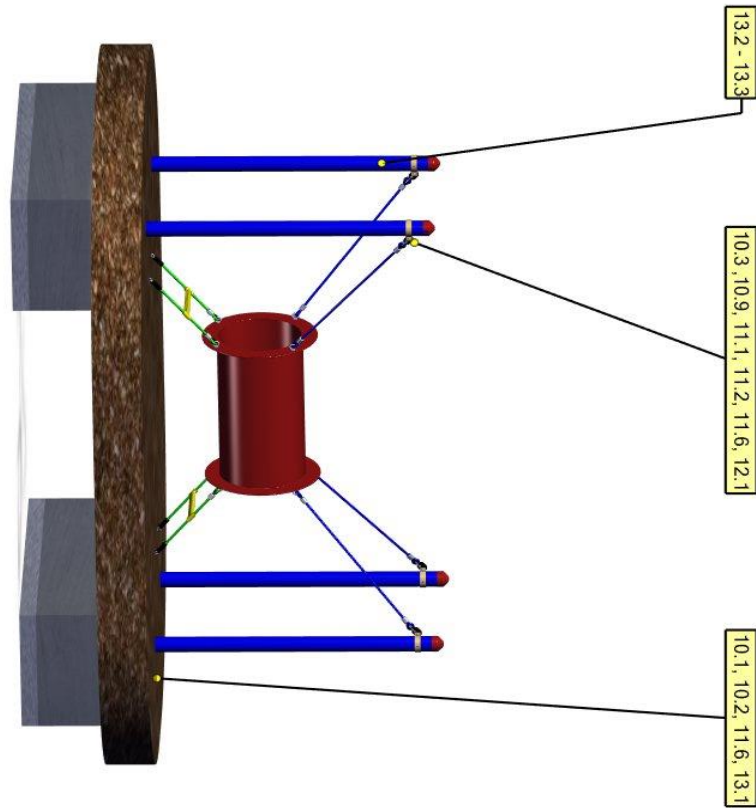

10 Monthly maintenance

- 10.1 Check the spaces between the equipment and the ground (clearance and height of fall).
- 10.2 Check the ground surface in the area with fall protection for hard objects and loose foundations.
- 10.3 Check all connecting elements and fittings for wear and tear and tighten if necessary. Replace damaged or missing parts.
- 10.4 Check that moving metal parts (joints, springs, etc.) move smoothly and are not worn. Replace if necessary. It is not necessary to lubricate joints as we only use maintenance-free metal roller bearings.
- 10.5 Check all attachments such as chains, ropes, nets, etc. for damage and replace if necessary.
- 10.6 Check rubber parts, sleeves, etc. for wear and tear or damage and replace if necessary.
- 10.7 If necessary, remove excess padding material from the post footings due to danger of rotting.
- 10.8 Check the surface of wooden parts for damage caused by the weather or external influences and mould. Repair or replace if necessary.
- 10.9 Check the surface of plastic and metal parts, e.g. slides, for damage and replace if necessary.

11 Quarterly maintenance

- 11.1 Detailed inspection of the operation and stability of the equipment, paying particular attention to any wear and tear.
- 11.2 Tighten all forms of attachment.
- 11.3 Repaint and retreat surfaces.
- 11.4 Maintenance of fall protection surfaces.
- 11.5 Lubrication of joints.
- 11.6 Check the height of fall and top up with loose filler if necessary. If the posts are labelled, top up to the mark.
- 11.7 Retighten all bolts

12 Half yearly maintenance

- 12.1 The stability of supporting posts, supports, foundations etc. has to be checked. The safety level of the entire system has to be checked after repairs have been carried out or additional system components have been installed or replaced.



Attention

Annual Maintenance

13 Annual maintenance

- 13.1 Check if the equipment, foundations and surfaces are safe for operation.
- 13.2 In particular, the equipment should be checked for decay and corrosion. It may be necessary to dig out or excavate certain components. Zinc paint should be applied to corroded areas and scratches.
- 13.3 Check complete stability (check posts, bracing, foundations, etc.).
- 13.4 Ascertaining whether there are any changes in equipment safety as a result of repairs that have been carried out or components that have been added or replaced.



Attention

The equipment must be inspected by someone **with the necessary expertise** in strict compliance with the instructions issued by Huck Seiltechnik GmbH.

A copy of the inspection record should be given to the operator, who must confirm receipt.

15 Hand over document



After the installation of the equipment pass the installation and maintenance documents to the operator. The operator has to receive the hand over documents. The complete filled and signed hand over document should be sent to the supplier.

Art.-No.: 4959-80

Type of item: Adventure Bridge Crawl Tunnel

Serial number: _____

Customer or operator (Town, Town council, Kindergarten, etc.):

Competent person in charge:

Installation company (address):

Responsible assistant (assembler):

Received the complete assembly instructions, maintenance instructions and maintenance printout .

(Signature of operator)
(Stamp)

(Signature of installation company)

Date: _____