

## **A Assembly instruction**

### **Easy – Climb 4**

### **Part no. 4591-40-4**

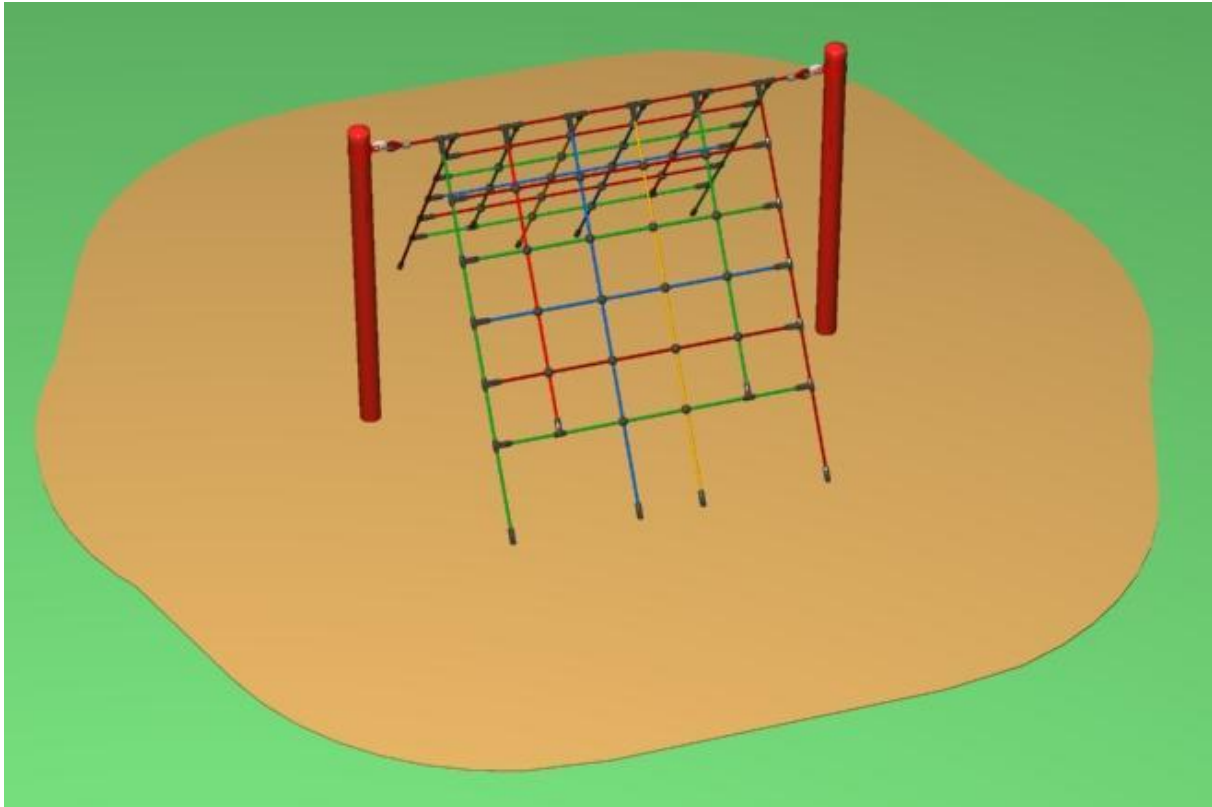

**Operator:** \_\_\_\_\_

**Location:** \_\_\_\_\_

**Attention!**

**The distance between the center of the poles is 2.25m.**

**In case of an eventual add-on of any other rope-parcours elements (e.g. “Haiger”, “Dillenburg”, “Fun Parcours”, etc.) the different distance between the poles has to be considered!**

**Revision history**

Revision 0 – 2007- 12-04  
First released version

Assembly instruction SP

Revision 3 – 2011-07-04  
Sicherheitsbereich FH

All rights reserved

© Copyright 2007 Huck Seiltechnik GmbH

## Table of content

<b>A</b>	<b>Assembly instruction Easy – Climb 4 part no. 4591-40-4</b> .....	<b>1</b>
1	Introduction installation.....	4
2	Data sheet Easy – Climb 4 part no. 4591-40-4 .....	5
3	Scope of supply, parts list with part numbers.....	8
4	Assembly instructions .....	10
5	Examination after installation.....	15
<b>B</b>	<b>Maintenance instruction Easy – Climb 4 part no. 4591-40-4</b> .....	<b>15</b>
6	Introduction maintenance.....	17
7	General maintenance information.....	18
8	Maintenance timetable .....	20
9	Regular maintenance (image).....	21
10	Monthly maintenance (text) .....	22
11	Quarterly maintenance (text).....	22
12	Half-yearly maintenance (text).....	22
13	Annual maintenance - main inspection (text).....	23
14	Maintenance printout .....	25
15	Hand-over document .....	27

## Tables' legends

Table 3-1: Scope of supply, parts list with part numbers .....	8
Table 3-2: Scope of supply, parts list with part numbers .....	9

# 1 Introduction installation

## 1.1 General information

This equipment should be installed, inspected, maintained and operated in accordance with EN1176-7 guidelines.

**Before installation work commences, please check that you have all of the equipment and fixation components in the parts list provided (see tables 3-1 and 3-2).**

**Please consider that the installation has to be carried out only on even terrain (max. slope up to 3%).**

Any spare parts that may be required can be obtained directly from your supplier or HUCK Seiltechnik GmbH.

Address: Huck Seiltechnik GmbH  
Dillerberg 3  
35614 Asslar/Berghausen  
Phone +49 (0)6443 / 8311-0  
Fax +49 (0)6443 / 8311-79

Please do not hesitate to call your supplier **+49 (0)6443/ 8311- 99** if you have any problems during installation or in case of any other questions.



Following installation, complete assembly instructions, maintenance instructions and a maintenance record must be sent to the operator who must confirm receipt in writing. See the last page of this document!!!



All nuts and bolts are hot-dip galvanised or stainless steel.

One of the characteristics of stainless steel is that uncontrolled cold welding may occur when the nuts are tightened. To prevent this, it is necessary to spray the nuts and bolts with Teflon spray (for example HTS plus Teflon no. 893128, can be purchased from the company Würth) or another similar lubricant.

---

## 2 Data sheet Easy – Climb 4 part no. 4591-40-4

1. Space required without safety area: 2,35 m x 2,20 m  
Space required including safety zone: 4,70 m x 4,60 m  
Height of fall: max. 1,50 m  
**Images (individual drawings) are not true to scale!!**
2. Specified ground surface:

Surface material	Description mm	Minimum thickness of layer mm	Maximum height of fall mm
Lawn/top soil			<= 1000*
Chipped bark	grain size 20 – 80	300/400	<= 2000/3000
Wood chippings	grain size 5 – 30	300/400	<= 2000/3000
Sand	grain size 0,2 – 2	300/400	<= 2000/3000
Gravel	grain size 2 – 8	300/400	<= 2000/3000
Other ground surface materials	Like tested according to HIC		

\*In Germany, lawn is a sufficient ground surface in the safety zone for heights of up to 1,50 m.

3. Name and complete dimension of the largest part of the equipment  
2 steel posts Ø 102 mm; length 2,40 m
4. Name and weight of the heaviest part of the equipment:  
Steel post (1 piece) ~ 18 kg
5. Allowed age group: 2 years and up
6. **Attention! Equipment to be embedded in concrete**  
Concrete: C22/30  
Concrete requirement: ~ 1,30 m<sup>3</sup>  
Excavation:  
**2 x 0,80 m long x 0,80 m wide, total depth 0,90 m including 10 cm percolation layer.**  
Size of foundation:  
**2 x 0,80 m long x 0,80 m wide x 0,50 m high, upper edges of concrete rounded.**



**Upper edges of concrete are rounded! Foundation sizes apply for regular soil classification 4-5 (grown surface).**

**Soil classification 4: Light up to medium plasticity, interlaced, with little sediment (proportion < 30 % larger than 63 mm grain size in diameter)**

**Soil classification 5: Grounds of soil classification 3 and 4 with more sediment (proportion > 30 % larger than 63 mm grain size in diameter)**

**For safety reasons, foundations of sandy, soft grounds should be layered with a larger surface of at least 50%.**

7. Assembly time once steel posts are set in concrete: approximately 1 hour  
Number of persons required:

8. Any spare parts that may be required can be directly obtained from your supplier or Huck Seiltechnik GmbH

Address: Huck Seiltechnik GmbH  
Dillerberg 3  
D-35614 Asslar/Berghausen  
Phone +49 (0)6443 / 8311-0  
Fax +49 (0)6443 / 8311-79

We herewith confirm that this play equipment is tested and certified according to the new play equipment norm EN 1176.

### **Drawings / views**

All optical illustrations simply demonstrate the proportions/dimensions to be followed, but are not binding, technical equipment images.

Technical modifications supporting the advancement of our articles are subject to change.

### **Tolerances / proportions**

Due to the quality and characteristics of equipment parts, minor dimensional tolerances over drawings data are possible.

This regards all visible dimensions, except for foundation dimensions respectively dimensions below OK ground surface/play surface.

### 3 Scope of supply, parts list with part numbers

#### 3.1 in letters (attention – number of items refer to 1 unit!!)





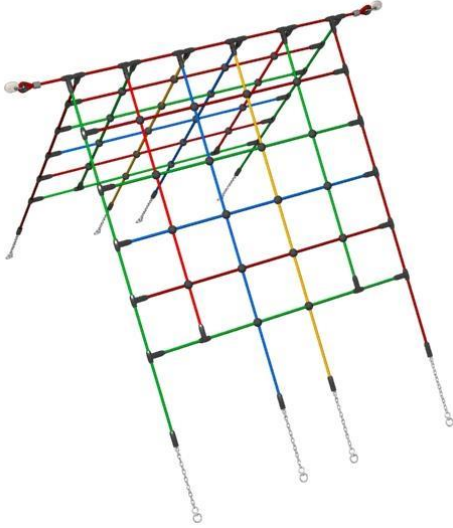



Table 3-1: Scope of supply, parts list with part numbers

Pos.	Number of items	Element / description	Size	O.K.	Missing
1	2	Steel posts	Ø 102 mm - 2,40 m long		
2	2	Red post shoes made of synthetic	für Ø 102 mm		
3	2	Tube clamps (with coach bolts and stop screw nuts)	.		
4	2	Tube clamps with threaded bolt M10 x 150 mm + 2 nuts			
5	1	Play equipment part <b>(Net element, pre-assembled)</b>			
6	8	Scew-in ground anchors			
100	1	Red paint (1 can) + paint brush	½ liter		
101	6	Self-cutting PIAS screw (for pos. 2)	3,5 x 19 mm		



### 3.2 as symbols

Table 3-2: Scope of supply, parts list with part numbers

Pos.	Num-ber of items	Symbol
1	2	 Ø 102 mm - 2,40 m long
2	2	 for Ø 102 mm
3	2	 for Ø 102 mm
4	2	 for Ø 102 mm
5	1	
6	7	
100	1	 Paint (red) ½ liter
101	6	 3,5 x 19 mm

## 4 Assembly instruction

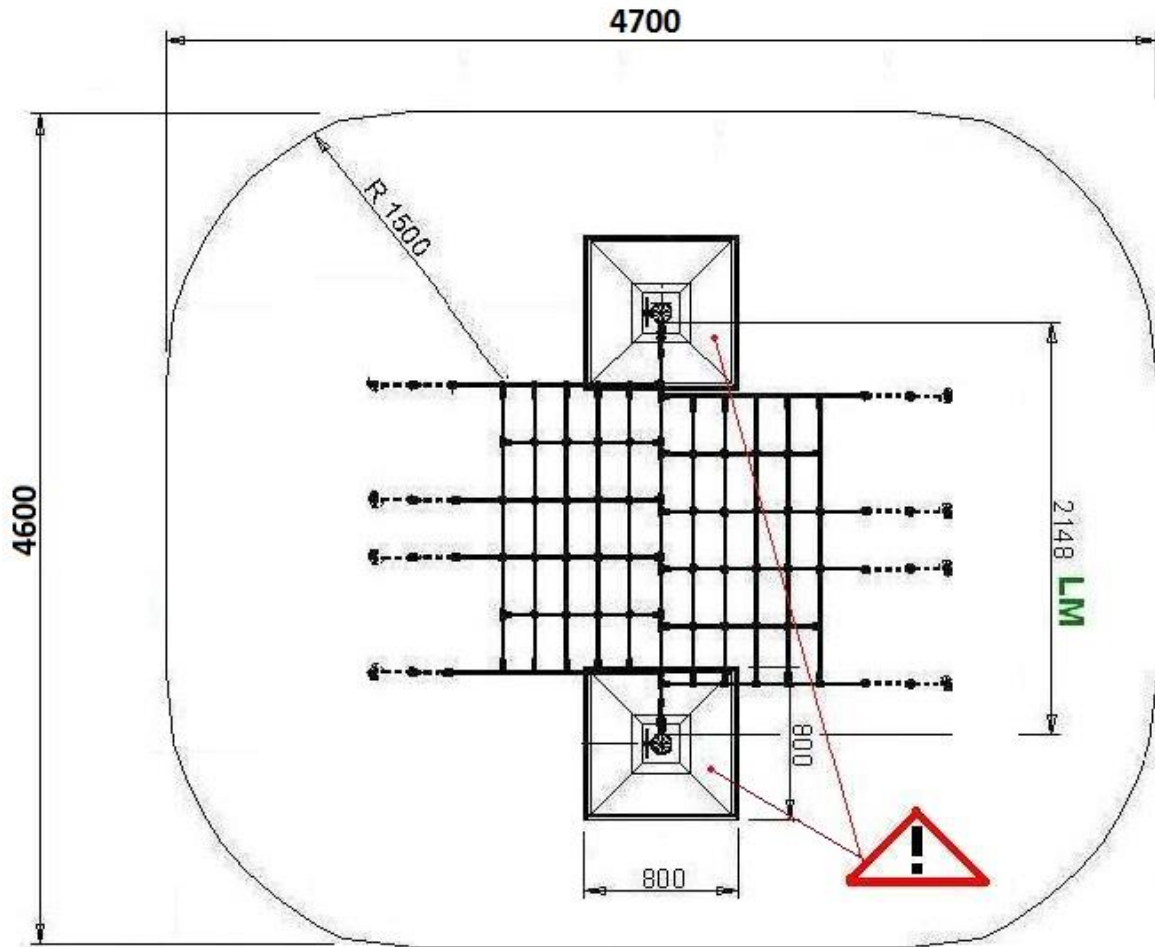

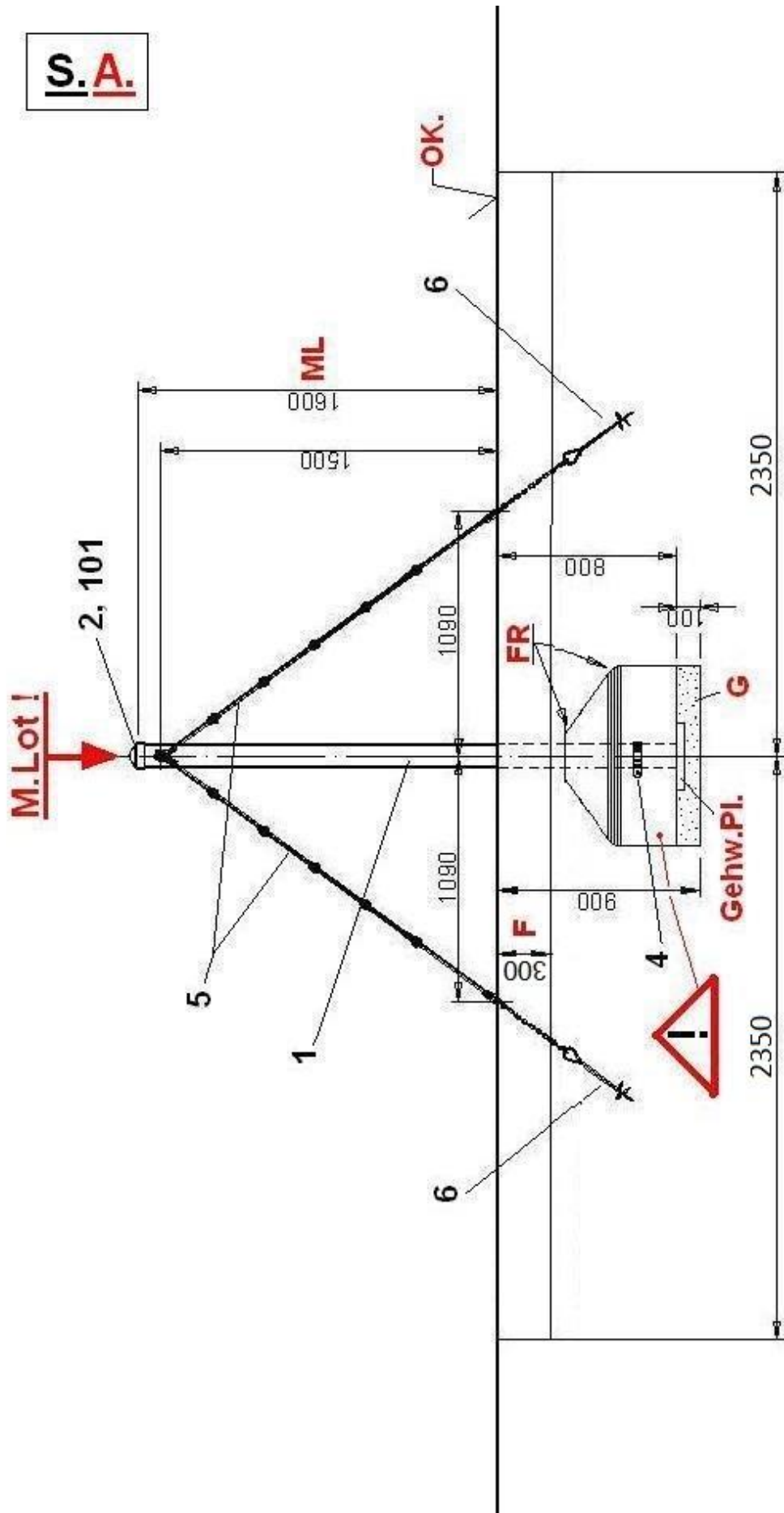

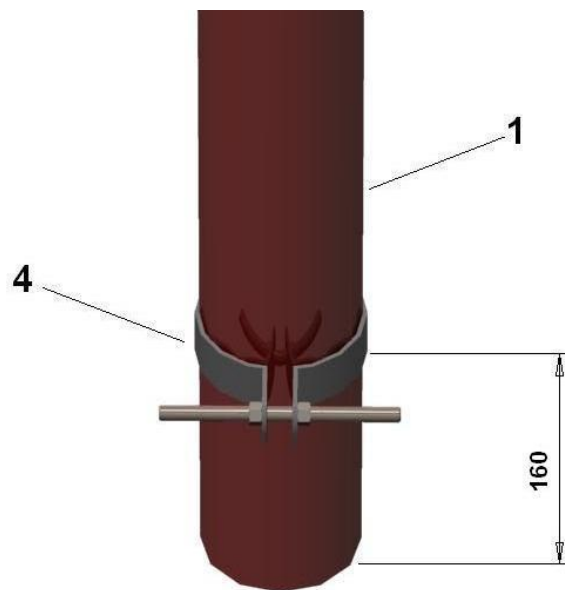
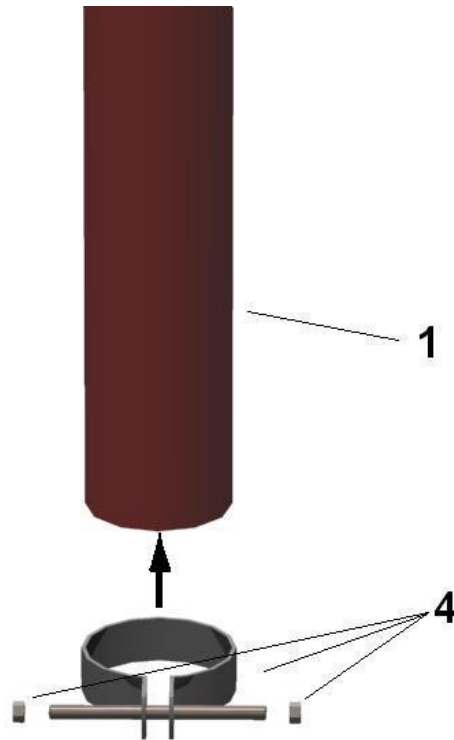

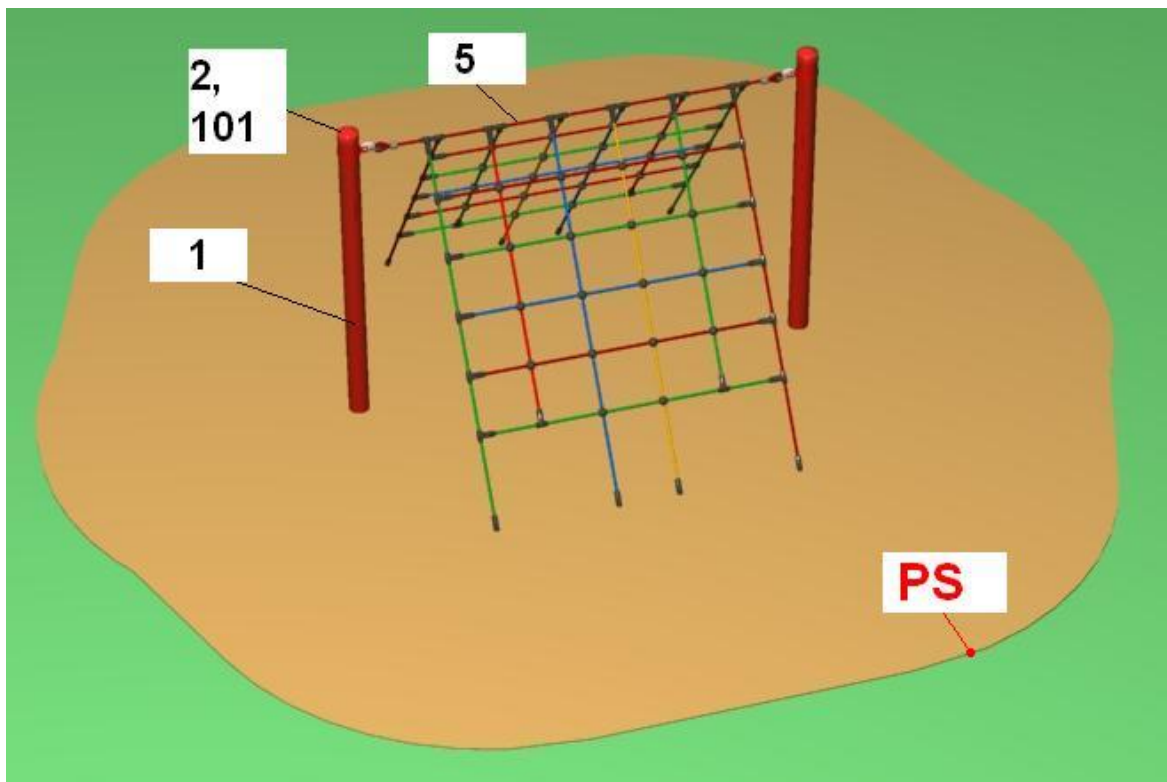
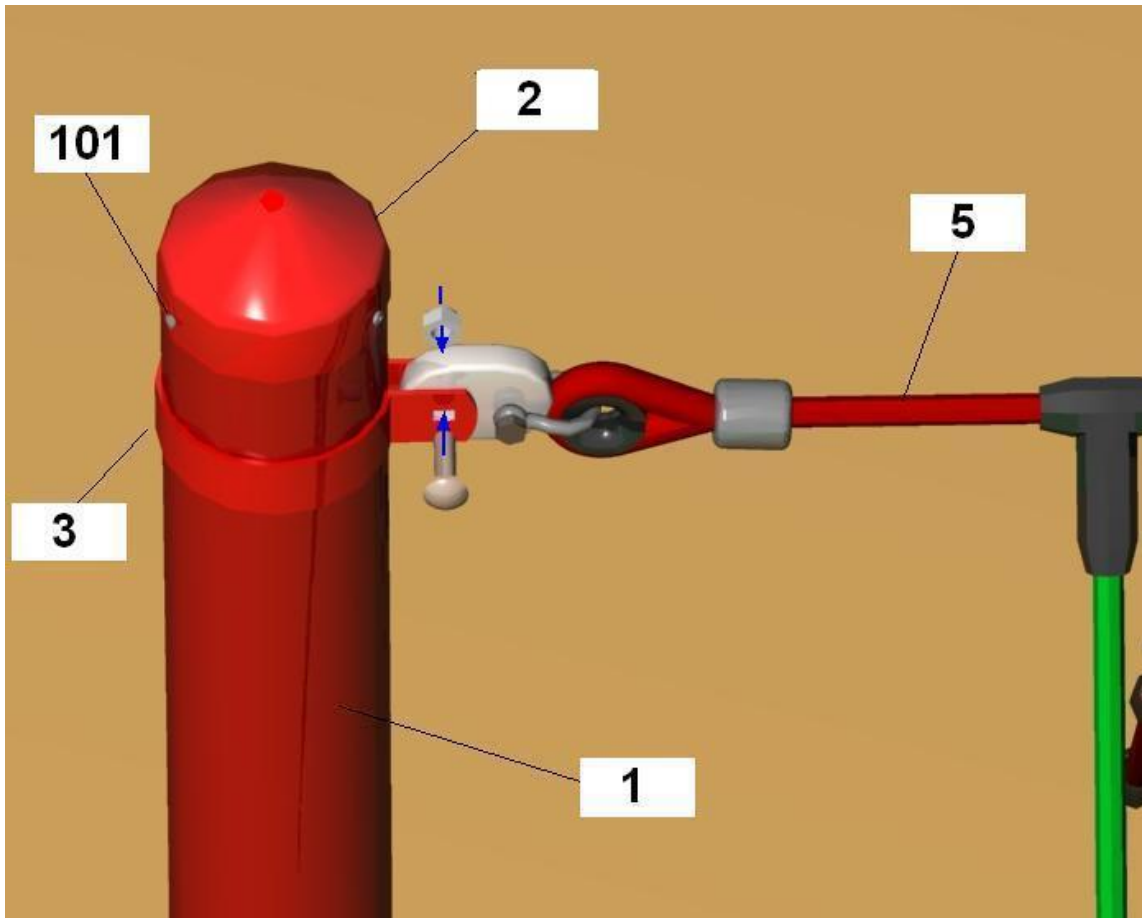

	<b>EASY – Climb 1, part no. 4591- 40-4</b> <b><u>Explanation to abbreviations and signs:</u></b>
<b>AB</b>	Setting time for concrete C25/30 minimum 7-8 days
<b>AM</b>	Dimension between axes of posts (center-center)
<b>LM</b>	Clear post dimension
<b>D</b>	Concrete C25/30 ( for foundation )
<b>DR</b>	Top view
<b>F</b>	Fall protection
<b>FR</b>	Foundation radius at least 10 cm
<b>Gehw. PI.</b>	Liner, e.g sidewalk slab, is to be underlaid to the posts by the customer! Top edge – percolation layer (see drawing)
<b>G</b>	Percolation layer 10 cm
<b>S.A.</b>	Side view
<b>O.K</b>	Upper play level
<b>M.Lot !!</b>	Posts are absolutely to be assembled perpendicular!
<b>PS</b>	Space required including safety area
<b>ML</b>	Length of posts above play level
	<b><u>Upper edges of concrete are rounded! Foundation sizes apply for regular soil classification 4-5 (grown surface).</u></b> <b><u>Soil classification 4:</u></b> Light up to medium plasticity, interlaced, with little sediment (proportion < 30 % larger than 63 mm grain size in diameter). <b><u>Soil classification 5:</u></b> Grounds of soil classification 3 and 4 with more sediment (proportion > 30 % larger than 63 mm grain size in diameter) <b><u>For safety reasons, foundations of sandy, soft grounds should be layered with a larger surface of at least 50%.</u></b>

See drawings

---

## 5 Examination after installation

---



If the equipment is not installed in a secure manner you must ensure that access is closed to the public!

### Hinweis

---

#### 5.1 Marking the filling level

- Markings on the equipment to indicate filling levels of fall protection material (for example of loose filling material).

#### 5.2 In the following cases the equipment is not yet safely installed:

- safe installation of the equipment is not fully completed
- impact absorbing surface is not installed yet
- the upkeep of occupational safety through appropriate maintenance can not be guaranteed.

#### 5.3 Removing assembly accessories

- Please make sure that all accessories, which were used for the installation of the equipment, are removed from the play area! Only then the equipment can be declared open.

#### 5.4 Details concerning inspection of the equipment prior to the first use

- No acceptance test specifications apply prior to first use.

#### 5.5 Retighten bolts

- Please retighten all bolts after one week of initial use. Later, it is sufficient to retighten the bolts with every maintenance.





## **B Maintenance instruction**

### **Easy – Climb 4**

### **Part no. 4591-40-4**

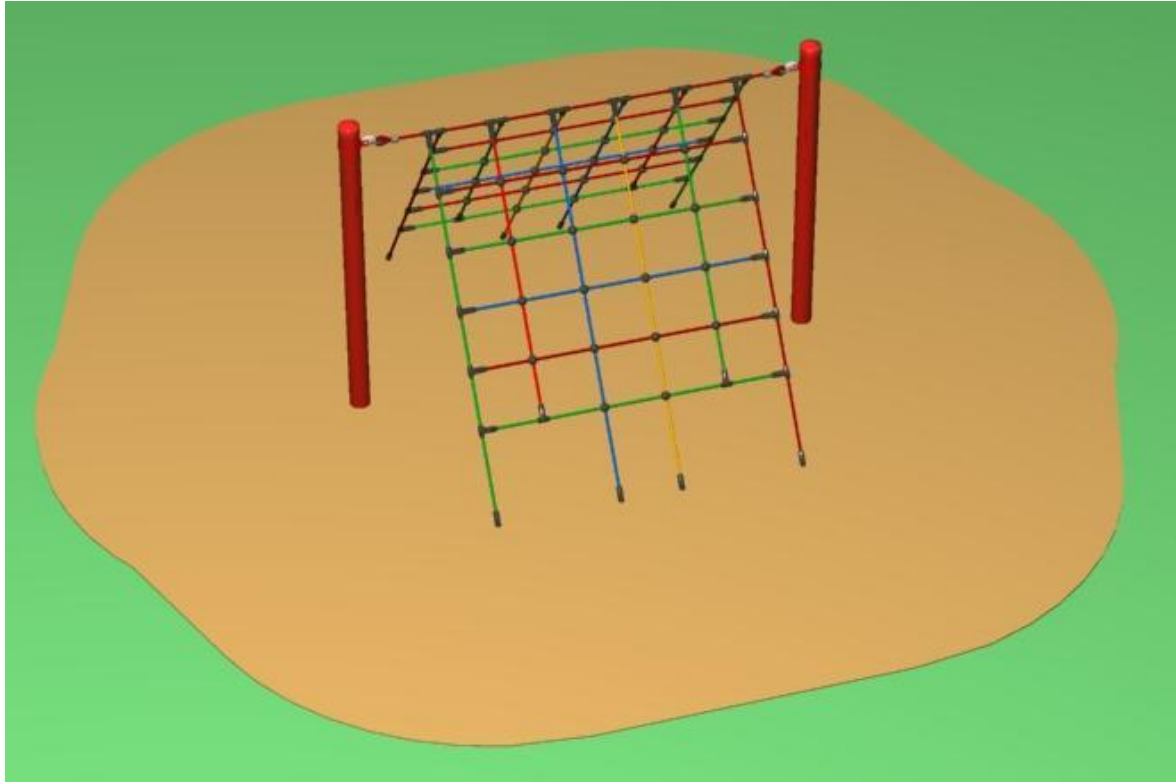

**Revision history**

Revision 0 – 2007-12-04  
First released version

Assembly instruction SP

Revision 3 – 2011-07-04  
Sicherheitsbereich FH

All rights reserved

© Copyright 2007 Huck Seiltechnik GmbH

---

## 6 Introduction maintenance

### 6.1 General information

This equipment should be installed, inspected, maintained and operated in accordance with EN1176-7 guidelines.



**Please note:** Providing any necessary repairs are carried out, a piece of play equipment that is inspected regularly cannot become so damaged that it is dangerous.

---

Any spare parts that may be required can be obtained directly from your supplier or HUCK Seiltechnik GmbH

Address: Huck Seiltechnik GmbH  
Dillerberg 3  
35614 Asslar/Berghausen  
Phone +49 (0)6443 / 8311-0  
Fax +49 (0)6443 / 8311-79



This equipment should only be assembled, maintained and repaired by **persons with the necessary expertise.**

A copy of the inspection record is to be handed over to the operator, who must confirm receipt.

---

**This maintenance instruction is based on the standard “EN 1176-1:2008”.**

## **7 General maintenance information**

### **7.1 Maintenance intervals**

Maintenance intervals are based on average use. Please note that more frequent inspections and/or maintenance are required if the play equipment is subject to intensive use!

### **7.2 Inspection frequency**

The frequency of inspections must be based on actual use. Factors that affect frequency include vandalism, location (e.g. coastal proximity), air pollution and the age of the equipment!

### **7.3 Maintenance products and procedures**

All nuts and bolts are hot-dip galvanised or stainless steel. One of the characteristics of stainless steel is that uncontrolled cold welding may occur when the nuts are tightened. To prevent this, it is necessary to spray the nuts and bolts with Teflon spray (for example HTS plus Teflon no. 893128, can be purchased from the company Würth) or another similar lubricant.

### **7.4 Spare parts**

All spare parts must comply with the manufacturer's specifications!

### **7.5 Identifying spare parts**

All spare parts are listed in the parts list. You find the parts list in chapter 3.

### **7.6 Special instructions for the disposal of individual equipment components**

No special instructions are necessary.

### **7.7 Special measures in the starting time**

No later than 2 weeks after assembly, all screwed connections should be checked and tightened if necessary.

### **7.8 Maintenance of fall protection surfaces**

Surfaces providing fall protection must also be maintained regularly. It is particularly important to maintain the correct level of loose surface material and add more if necessary.

---

## 7.9 Faults

---



Damages must be repaired as soon as they are detected. If serious defects that affect the safety cannot be repaired straight away, the playground equipment must be closed to the public with immediate effect.

---

## 7.10 Loose screws

---



Loose screws always cause quality problems and put safety at risk. Therefore, loose screws should always be tightened and checks should be carried out to ensure that there are no missing screws (watch for see-through holes, for example).

---

## 7.11 Preventing equipment use

The use of the equipment should be prevented: in case of incomplete installation, disassembly, maintenance, repairs and faults.

## 7.12 Guarantee respectively warranty

Steel posts and post shoes are covered by our guarantee if regular maintenance is carried out and recorded in writing. Our general terms and conditions apply. Maintenance of steel poles first takes place after 3 years. The steel posts must be excavated down to the concrete foundations and checked **for corrosion**. Zinc paint should be applied to any corroded areas and scratches. Check ropes for abrasion. Ropes are to be re-impregnated once intensive abrasion occurs.

---

## 8 Maintenance timetable

### 8.1 Special advices

#### 8.1.1 Maintenance interval

We strongly advise to carry out inspections and maintenance work within the specified periods as use of the equipment, weather and malicious vandalism cause wear and tear that compromise safety and function of the equipment.

#### 8.1.2 Maintenance intervals in the event of intensive use

Please note that more frequent inspections and/or maintenance are required if the play equipment is subject to intensive use!!!

#### 8.1.3 Faults that compromise safety

---



In the event of a fault that compromises safety, quick action must be taken: The equipment has to be closed immediately and repaired or dismantled.

---

#### 8.1.4 Faults that compromise function

---



Faults that compromise function should also be repaired immediately. Such faults lower the value of the equipment to the user and encourage malicious vandalism, which may render the equipment less safe. Any damages should be repaired immediately.

---

## 9 Regular maintenance (image)

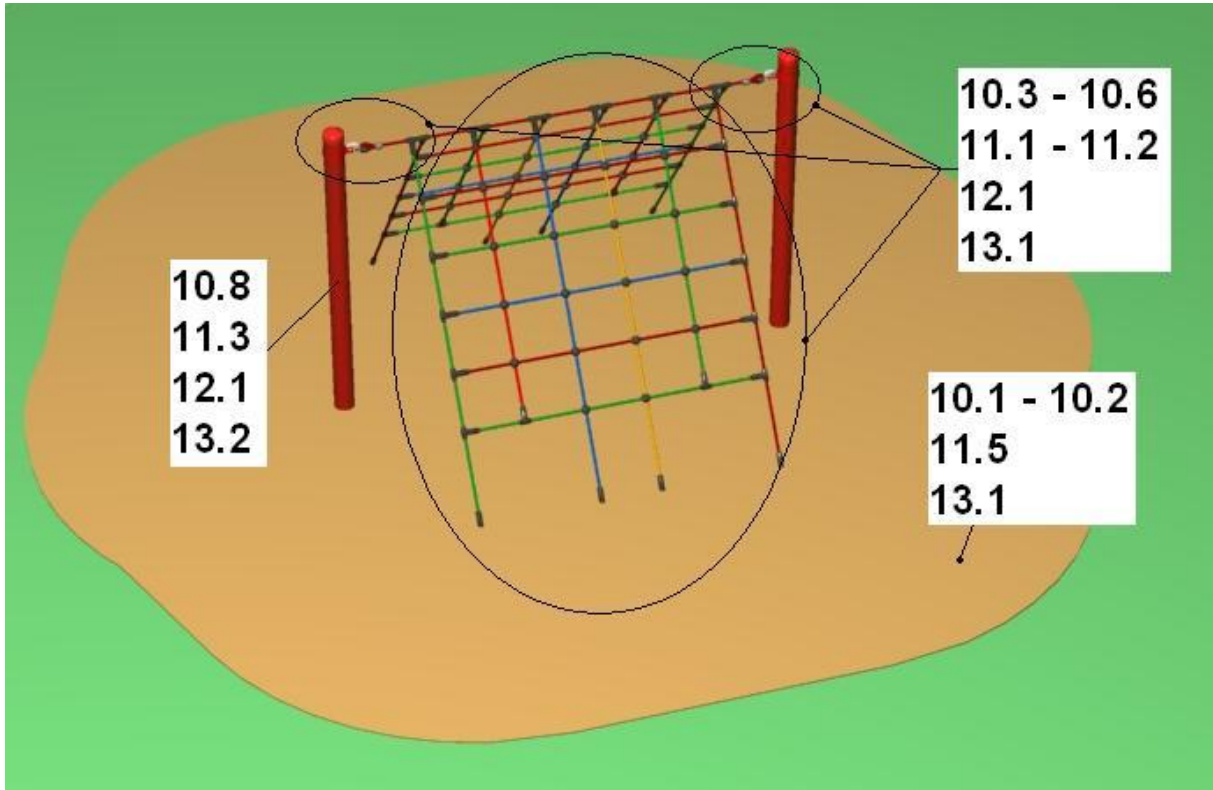

## **10 Monthly maintenance (text)**

- 10.1 Check the spaces between the equipment and the ground (clearance and height of fall).**
- 10.2 Check the ground surface of fall protection for hard objects and loose foundations.**
- 10.3 Check all connecting elements and fittings for wear and tear and tighten if necessary. Replace damaged or missing parts.**
- 10.4 Check that moving metal parts (joints, springs, etc.) move smoothly and are not worn. Replace if necessary. It is not necessary to lubricate joints as we only use maintenance-free metal roller bearings.**
- 10.5 Check all attachments such as chains, ropes, nets, etc. for damage and replace if necessary.**
- 10.6 Check rubber parts, sleeves, etc. for wear and tear or damage and replace if necessary.**
- 10.7 Check the surface of wooden parts for damage caused by the weather or external influences and mould. Repair or replace if necessary.**
- 10.8 Check the surface of plastic and metal parts, e.g. slides, for damage and replace if necessary.**

## **11 Quarterly maintenance (text)**

- 11.1 Detailed inspection of the operation and stability of the equipment paying particular attention to any wear and tear.**
- 11.2 Tighten all types of fastenings.**
- 11.3 Repaint and retreat surfaces.**
- 11.4 Maintenance of fall protection surfaces.**
- 11.5 Check height of fall protection material and fill up with loose filling material if necessary! If the posts are marked, fill up correspondingly.**
- 11.6 Retighten all bolts.**

## **12 Half-yearly maintenance (text)**

- 12.1 The stability of supporting posts, braces, foundations etc. has to be checked. Once repair respectively replacement is completed, the entire equipment has to be verified.**





## Annual maintenance – main inspection

---

### 13 Annual main inspection (text)

- 13.1 The complete equipment as well as the foundations and the surfaces are to be checked if they are generally safe.
- 13.2 The equipment is to be verified according to rotting and corrosion. For that some parts might have to be excavated. Zinc paint should be applied to any corroded areas and scratches.



The equipment must be inspected by someone **with the necessary expertise** in strict compliance with the instructions issued by Huck Seiltechnik GmbH.

**A copy of the inspection record is to be given to the operator, who must confirm receipt!**

---



## 14 Maintenance printout

Name of equipment: Easy - Climb 4 \_\_\_\_\_ / Part no. 4591-40-4 \_\_\_\_\_

Location: \_\_\_\_\_

Customer or operator:  
(Town, municipal, kindergarden)

Date of inspection	Inspector	OK	Accessible	Closed	Defects	Repaired by	Date

**Please copy and return to the manufacturer by Telefax +49 (0)6443 / 83 11 79 once a year after main inspection has been carried out.**

**Place the confirmation form in your existing play equipment files.**



---

## 15 Hand over document

---



**Attention**

After the installation of the equipment the installation and maintenance documents are to be handed over to the operator. The operator has to have the documents signed. The complete filled and signed hand over documents are to be sent back to the supplier Huck Seiltechnik GmbH via fax +49 (0)6443 / 83 11 79!

---

Part no.: 4591-40-4

Type of equipment: \_\_\_\_\_ Easy – Climb 4

Serial number: \_\_\_\_\_

**Customer or operator (town, municipal, kindergarden, etc.):**

\_\_\_\_\_  
\_\_\_\_\_

Person in charge:

\_\_\_\_\_  
\_\_\_\_\_

**Installation company (address):**

\_\_\_\_\_  
\_\_\_\_\_

Assistant in charge (assembler):

\_\_\_\_\_  
\_\_\_\_\_

Complete assembly instruction, maintenance instruction and maintenance printout received,

\_\_\_\_\_  
(Signature of operator) (Signature of installation company)  
(Stamp)

Date: \_\_\_\_\_