

A Assembly Instructions **Eagle´s nest tree, Art.-Nr. 4652-40**

Attention! Only use the assembly instruction included in the scope of delivery for the assembly, installation and maintenance of the respective equipment!



Operator: _____

Location: _____

Revisionshistorie

Revision 0 – 2013-10-17

Erste freigegebene Version

Montageanleitung SF

Revision 6 – 2022-02-08

Neue Form der Anleitung FH

Alle Rechte vorbehalten

© Copyright 2013 Huck Seiltechnik GmbH

Index of contents

A	Assembly Instructions Eagle´s nest tree, Art.-Nr. 4652-40	1
1	Introduction Assembling	4
2	Data sheet Eagle´s nest tree, Article No. 4652-40	5
3	Content, numbered bill of materials	8
4	Post installation checks	23
B	Maintenance Instructions Eagle´s nest tree , Art.-Nr. 4652-40	24
5	Introduction Maintenance	26
6	General maintenance information	27
7	Maintenance timetable	29
8	Regular maintenance	30
9	Monthly maintenance	31
10	Quarterly maintenance	31
11	Half yearly maintenance	32
12	Annual maintenance	32
13	Maintenance printout	34
14	Hand over document	35

Index of schedules

Schedule 3-1: Delivery content, numbered bill of materials	8
Schedule 3-2: Contents, numbered bill of materials	9

1 Introduction Assembling

1.1 General information

This equipment should be installed, inspected, maintained and operated in accordance with EN1176-7 guidelines.

Before installation work commences, please check that you have all of the equipment and fixation components in the parts list provided (see Tables 3-1 and 3-2).

Please consider that the installation has to be carried out only on even terrain (max.slope up to 3%).

Any spare parts that may be required can be obtained directly from your supplier.

Please do not hesitate to call your supplier if you have any problems during installation or in case of any other questions.



Attention

Following installation, complete assembly instructions, maintenance instructions and a maintenance record must be sent to the operator who must confirm receipt in writing. See the last page of this document.



Attention

All nuts and bolts are hot-dip galvanised or stainless steel.

One of the characteristics of stainless steel is that uncontrolled cold welding may occur when the nuts are tightened. To prevent this, it is necessary to spray the nuts and bolts with Teflon spray or another similar lubricant.

We hereby confirm that this play equipment has been tested and certified in accordance with the play equipment standard EN 1176-1:2017.

2 Data sheet Eagle's nest tree, Article No. 4652-40

1. Component zone : Ø 4.00 m
 Safety zone: Ø 8.20 m
 Height of fall: 1.75 m
 Total ground height: 5.73 m
 Fall protection area: 52,8 m²
2. Required safety surface:

Surface material mm	Description	Minimum thickness of layer mm	Maximum height of fall mm
Topsoil grass			<= 1000*
Chipped bark	20 – 80 grain size	300	<= 2000
		400	<= 3000
Wood chippings	5 – 30 grain size	300	<= 2000
		400	<= 3000
Sand	0.2 – 2 grain size	300	<= 2000
		400	<= 3000
Gravel	2 – 8 grain size	300	<= 2000
		400	<= 3000
Other surface materials	As recommended by manufacturer		

3. Name and overall dimension of the largest item of equipment:
 Steel post (1 piece) length 6.20 m, ø 193 mm
4. Name and weight of the heaviest item of equipment:
 Steel post (1 piece) 157 kg
5. Designed for age group: from 6 years and older
6. **Attention! System with concrete foundation**
 Concrete: C25/30 2,5 m³
 Foundation/Excavation:
 Top edge of concrete: 8 times 60 cm below ground level
9 times: 0.40 m long x 0.40 m wide x 0.50 m high,
depth: 1.00 m incl.10 cm rubble drain bed
1 time:0.40 m long x 0.50 m wide x 0.50 m high,
depth:1.00 m incl.10 cm rubble drain bed
1 time: 1.60 m long x 1.20 m wide x 0.80 m high,
depth:1.30 m incl.10 cm rubble drain bed

7.



Round off foundation edges (min.R = 100 mm)! Sizes of foundations are “4-5” (natural ground).

Soil class 4: soft to medium plasticity, interleave bound, with minor portion of stone (portion < 30% with bigger diameter of 63 mm grain size).

Soil class 5: ground with soil class 3 and 4 with big portion of stones (portion > 30% with bigger diameter of 63 mm grain size).

In case of sandy and soft soils, the surface measure of foundations have to be enlarged for about 50%!

8. Required assembly time, once foundations complete:
approx. 7 - 8 hours. Required assistance: 2 – 3 persons.
9. Any spare parts which may be needed can be obtained directly from your supplier
10. **We hereby confirm that this item of play equipment has been tested and certified in accordance with the play equipment standard EN 1176-1:2017.**

Drawings / Views

All optical drawings are showing only the measurements/dimensions and are no mandatory technical views of the complete item.

We reserve the right to change technical details of our articles which are serving for the further development of our articles and are reasonable for the customer.

Measurement tolerances

Because of the properties and characteristics of the components, minor measurement tolerances compared to the indication on the sketches are possible.

This concerns all shown measurements except the foundation measurements resp. measurements below upper edge ground level/play area.

3 Content, numbered bill of materials



3.1 In words





Schedule 3-1: Delivery content, numbered bill of materials



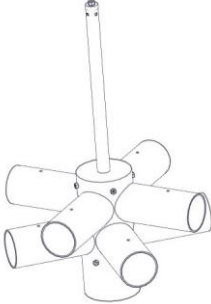
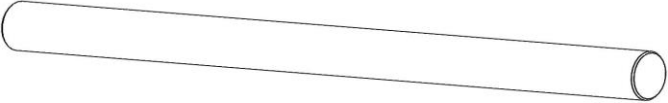

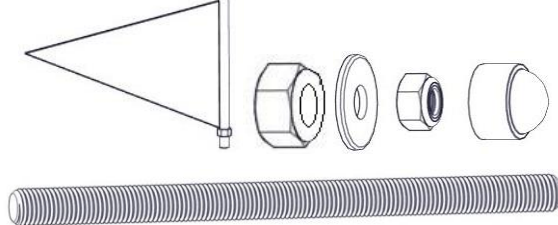

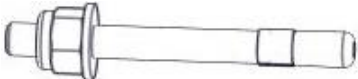
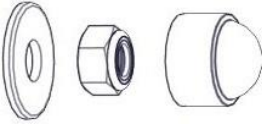
Pos.	Quantity	Element / Description	Size	O.K.	Mis-sing
1	1	Steel post	Ø 193mm x 6,20 m lg.		
2	1	Netzteil			
3	1	Mast cover	galvanized		
4	8	Glued laminated beams	Ø140mm x 1650mm		
5	1	Guy ropes (on mast hood pre-mounted)	~ Ø 3400mm		
6	1	Flag / blue (incl. Threaded rod & 2 nuts)	M16		
101	12	Stainless steel adapter 6er chain	M12		
102	12	Fix anchor	M12		
103	8	Stop nut, 2x washer, black cover cap	M12		
104	8	Stainless steel bearing (pre-assembled)	M12		
105	8	Red cover caps	Ø 140mm		
106	24	Pan head screw	3,5x25		
107	8	Threaded rod + 2x cap nut and 2x washer	M10 x 175 mm		
108	2	Loctite screw lock	je 3 ml		
109	8	Allen screws	M12x30 stainless steel		
110	1	Stainless steel bracket + screws	M5x25mm		
112	1	Anchor plate + ring nut M16	50cm x 50cm		
113	2 Set	Clamp protection rings black	Ø 240mm		
114	12	Self-tapping screws	4,5 x 60 mm		
	1	pipe Ø 250 on site (by the customer)	0,85 m long Ø250mm		

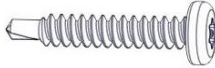

3.2 in Symbols

Schedule 3-2: Contents, numbered bill of materials

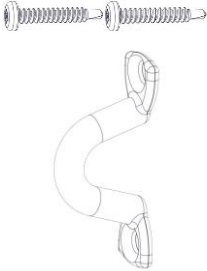
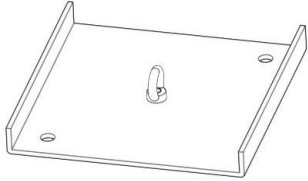
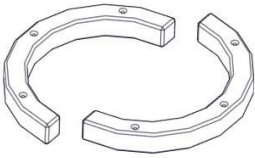
Pos.	Quantity	Symbol
1	1	 <p>Steel post Ø 193mm x 6,20 m lg.</p>
2	1	 <p>Play-element</p>
3	1	 <p>Mast cover galvanized</p>
4	8	 <p>Glued laminated beams Ø 140 mm, 1650 mm long</p>

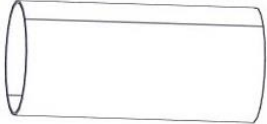
Pos.	Quantity	Symbol
5	1	 <p>Guy ropes (pre-mounted on the mast plate)</p>
6	1	 <p>Flag / blue incl. threaded rod and 2 M16 nuts (pre-assembled)</p>
101	12	 <p>Stainless steel adapter M12 6 chain</p>
102	12	 <p>Fix anchor M12</p>
103	8	 <p>Stop nut M12, washer, black cover cap</p>
104	8	 <p>Stainless steel bearing M12 (pre-assembled)</p>
105	8	 <p>red cover caps Ø 140 mm</p>

Pos.	Quantity	Symbol
106	24	 Pan head screw 3.5 x 25 mm
107	8	 Threaded rod M10 x 175 + 2x cap nut and 2x washer
108	2	 Loctite
109	8	 M12 x 25 mm stainless steel
110	1	 Stainless steel bracket + screws
112	1	 Anchor plate + ring nut M16
113	2 Satz	 Clamp protection rings
114	12	 Ø 4,5 x 60 mm
	1	 pipe Ø 250 mm, 0.85 m long on site (by the customer)

	<u>Explanations of abbreviations and signs:</u>
AE	Adjust chain to appropriate length
AB	Adhere to legal setting times
D	Concrete C25/30 (for foundations) Concrete requirement: 3.5 m ³
DT	Detail
D.be.	Fill the centre mast all around with concrete. (between empty conduit and centre mast)
F	Fall protection
G	Drainage layer
HK. entf.!!	remove wedges!!
KEA	Shortening chains
KNR	pipe min. Ø 250 mm
KN	pipe 50 mm above concrete level!
MF	Middle foundation
MKe	Place the mast in the empty conduit
MEb	Observe the marking when installing the post!
Mo	assemble
O.K	Upper edge of playing level
PS	Minimum safety area 52.8 m ²
	Position on the net and foundation
	<p><u>Top edges of concrete rounded! Foundation dimensions apply to normal soil classes 4-5 (grown soil).</u></p> <p><u>Soil class 4: Light to medium plasticity, interconnected, with low stone content (proportion < 30 % above a diameter of 63 mm grain size).</u></p> <p><u>Soil class 5: Soils of soil classes 3 and 4 with a large proportion of stones (proportion > 30 % above a diameter of 63 mm grain size).</u></p> <p><u>For safety reasons, the foundations of sandy, soft soils should be at least 50% larger in area.</u></p> <p><u>Translated with www.DeepL.com/Translator (free version)</u></p>
M.Lot !!	Make sure to set up the mast/post perpendicularly!

See drawings for details of shortcuts

Screw lock!

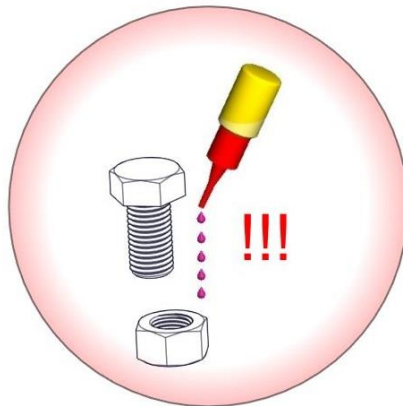

**All screws, nuts and sleeves
must be secured with Loctite
(except stop nuts)
(e.g. Torx sleeves M12 x 40 with at least 5 drops).**

4 Installation instruction

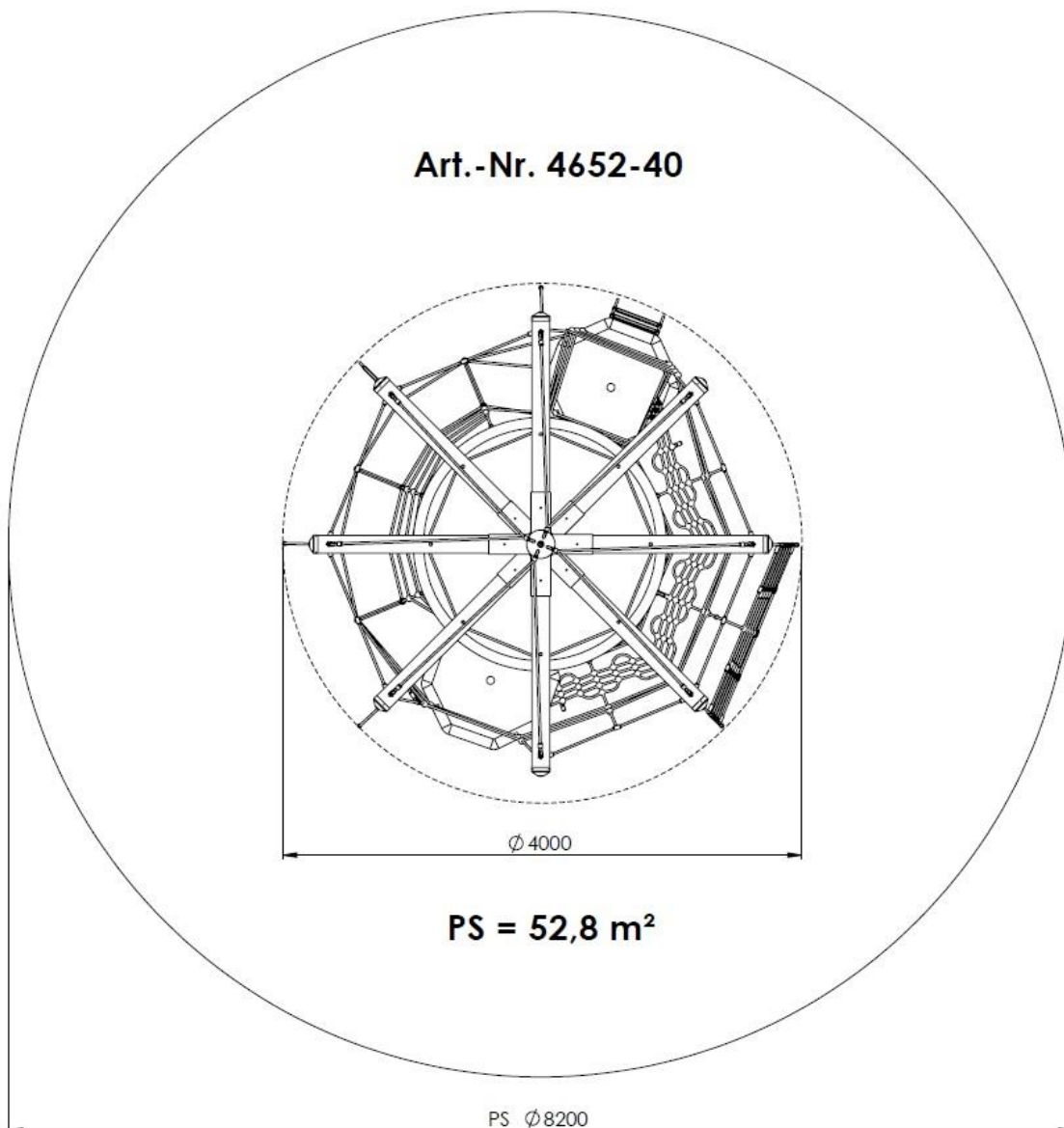

Front view

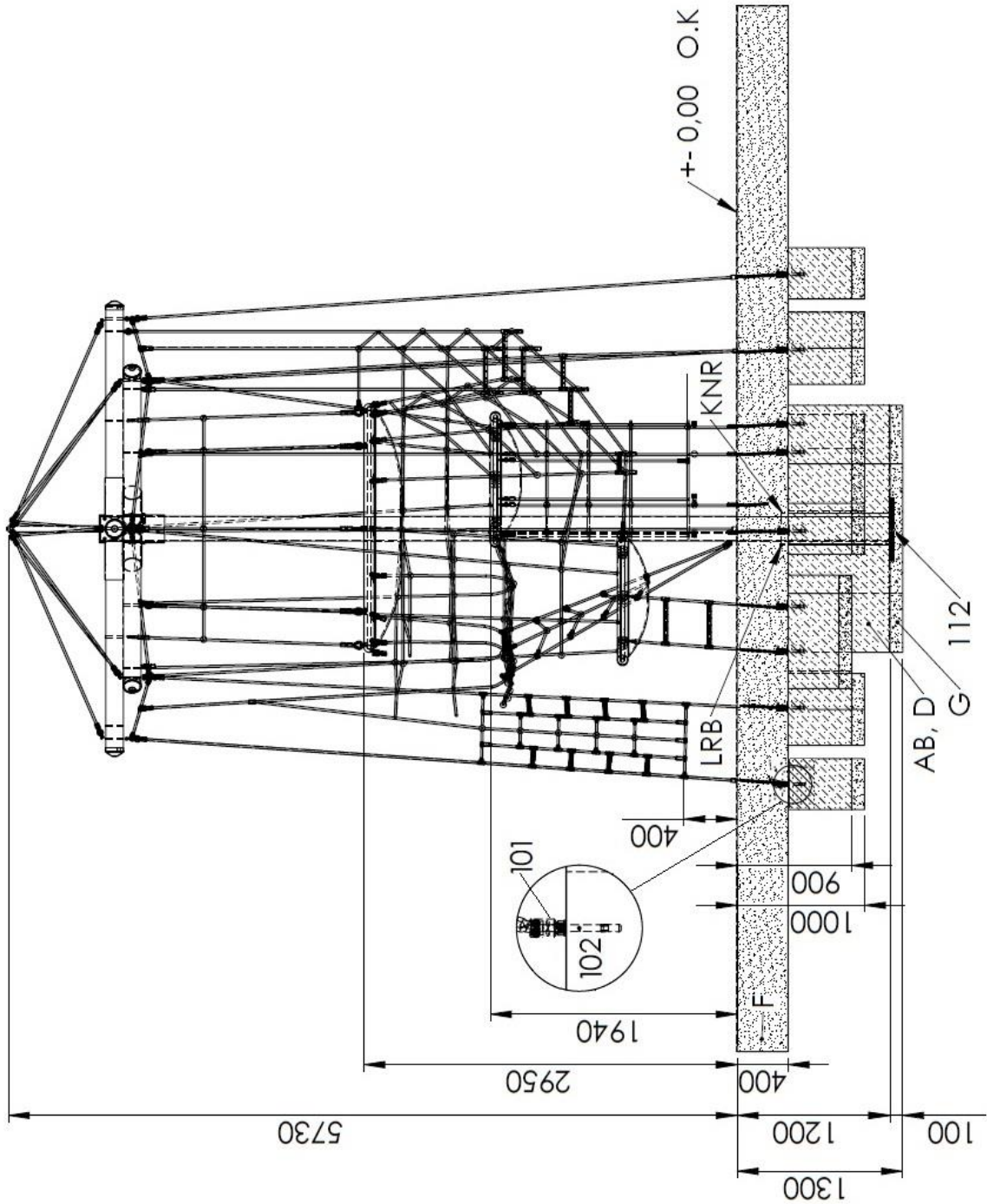

Top view

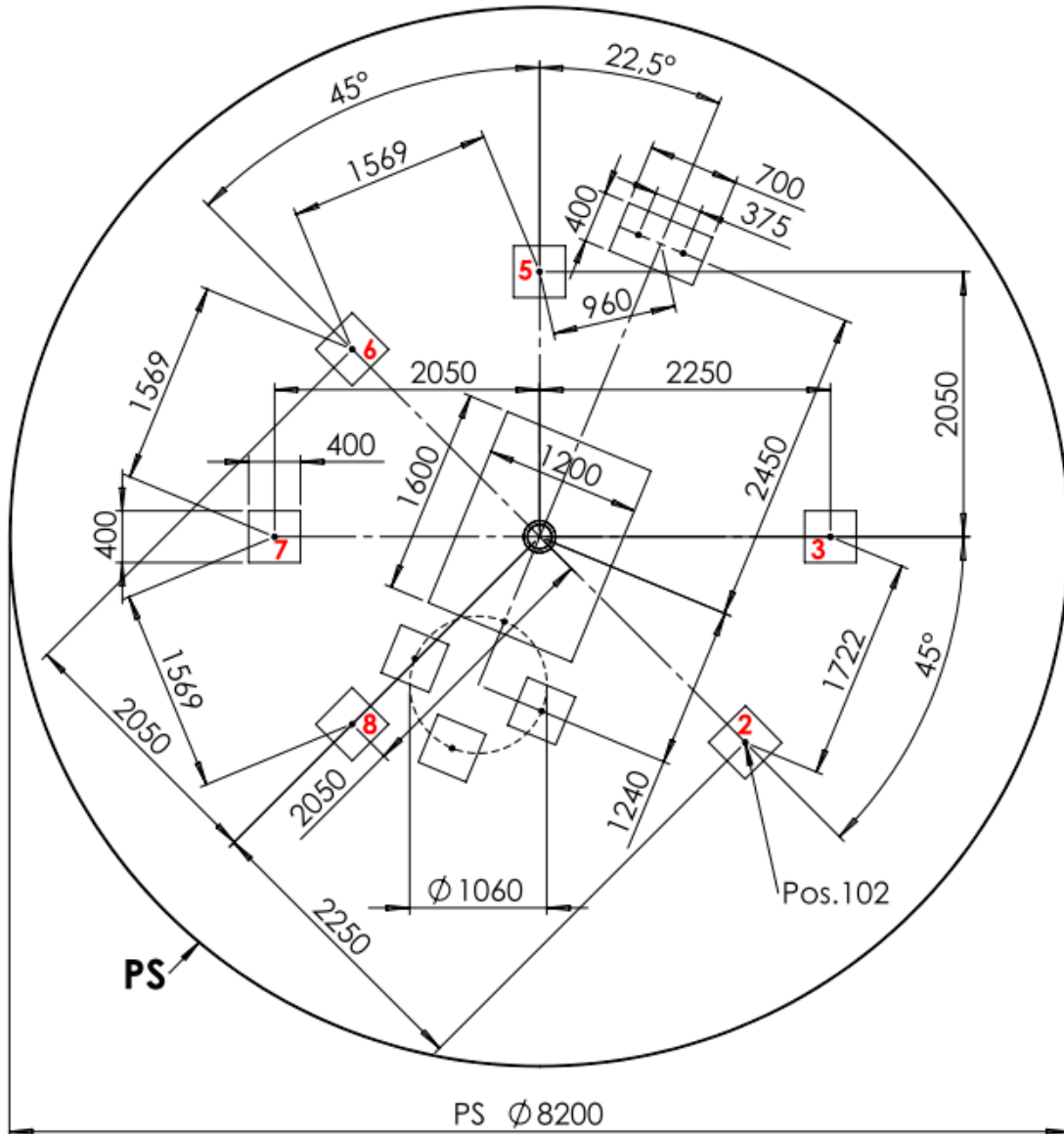

Alignment of the play equipment

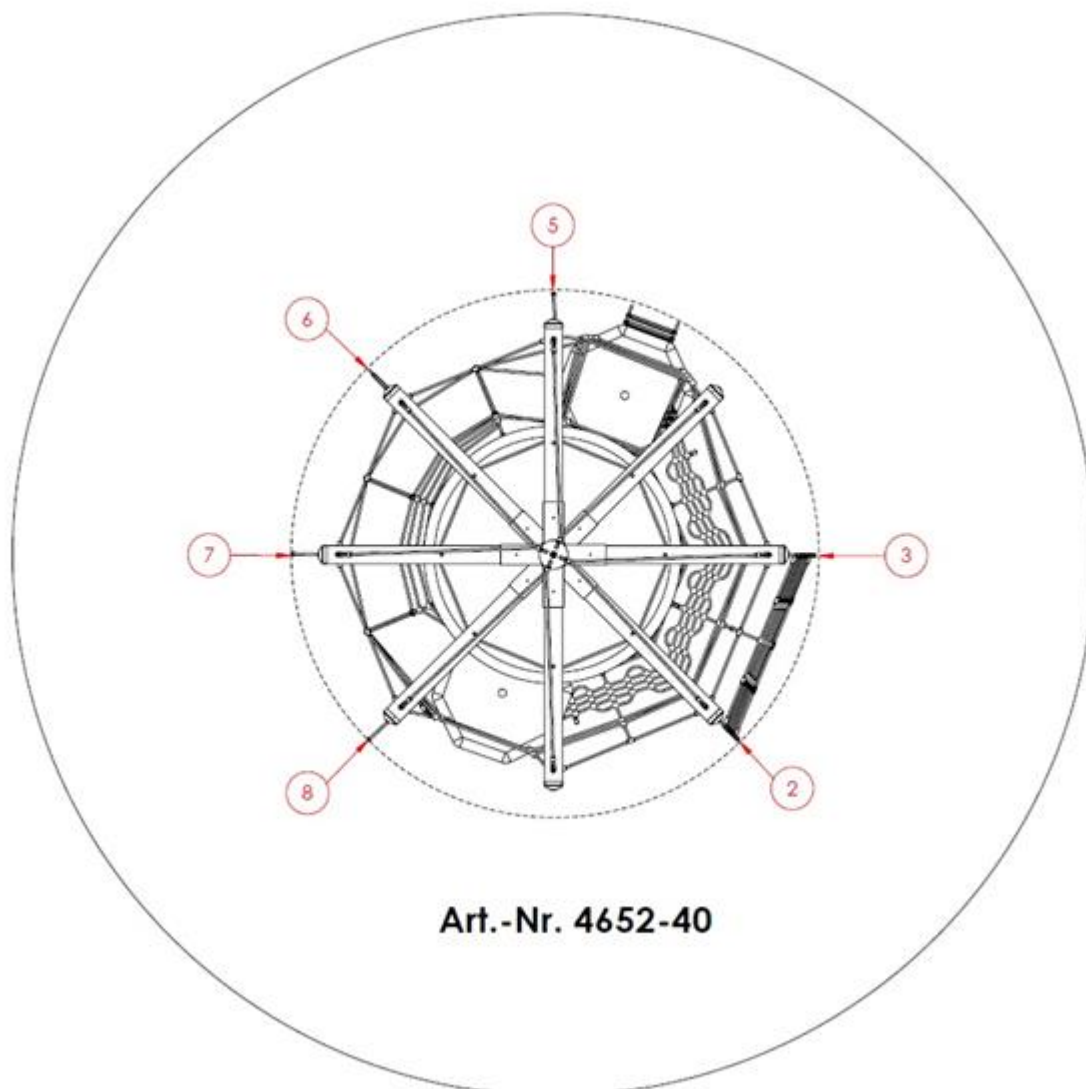

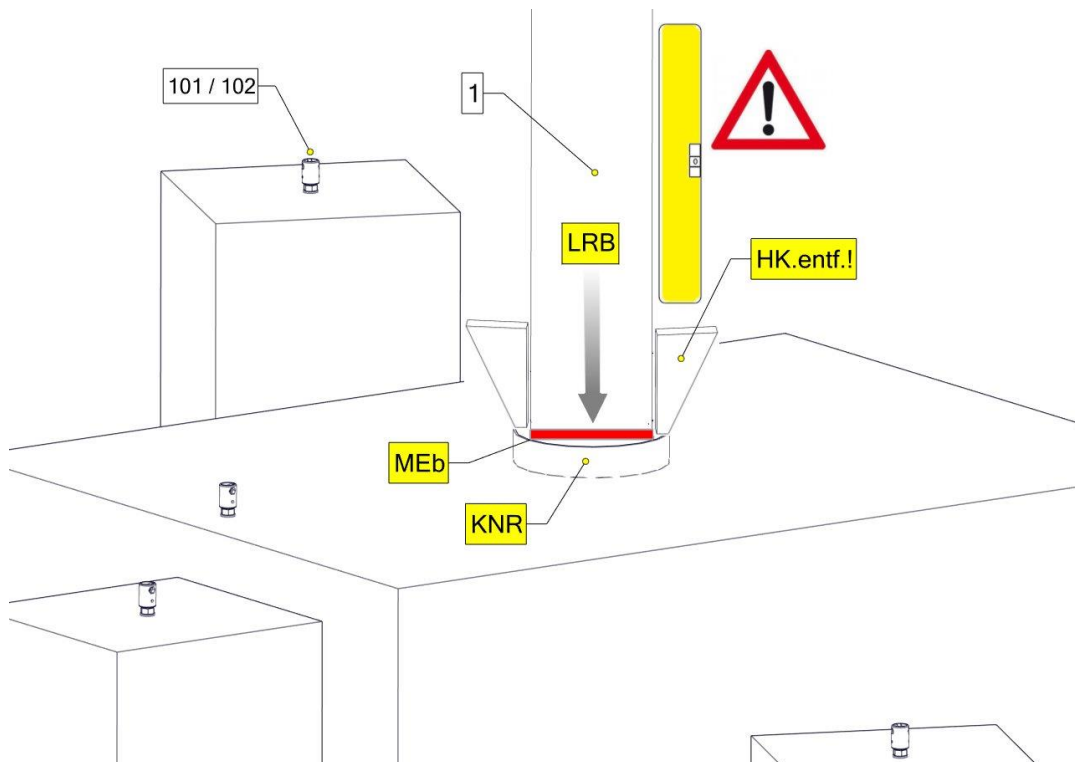
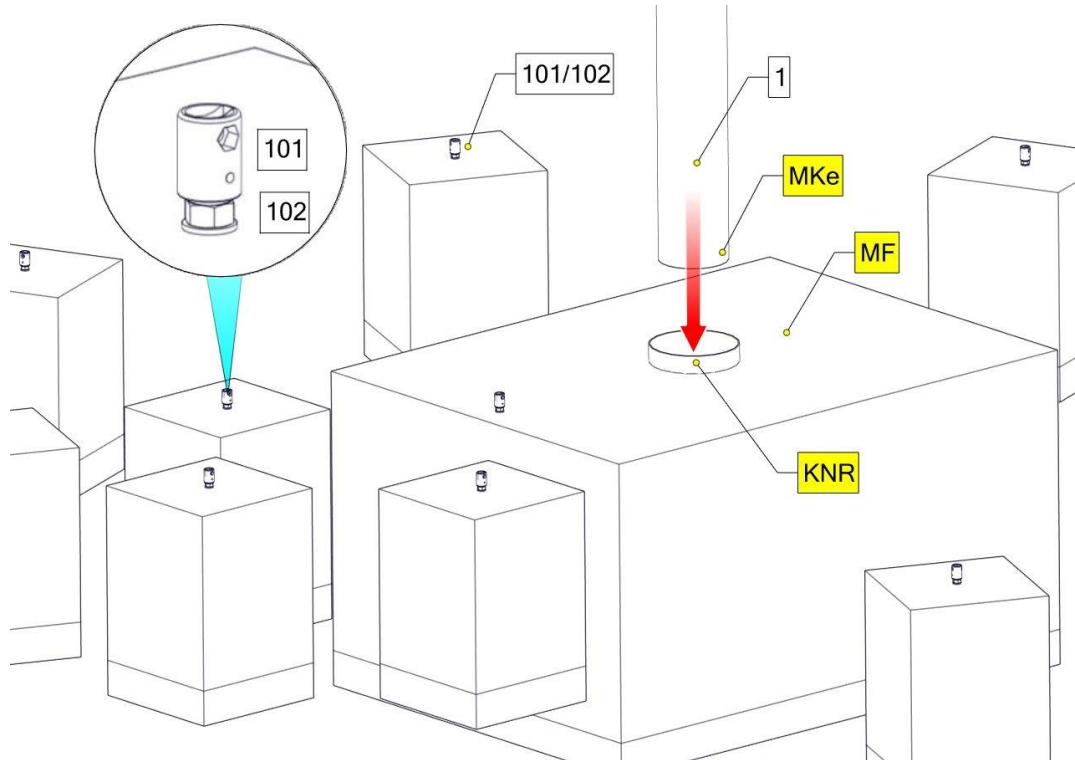

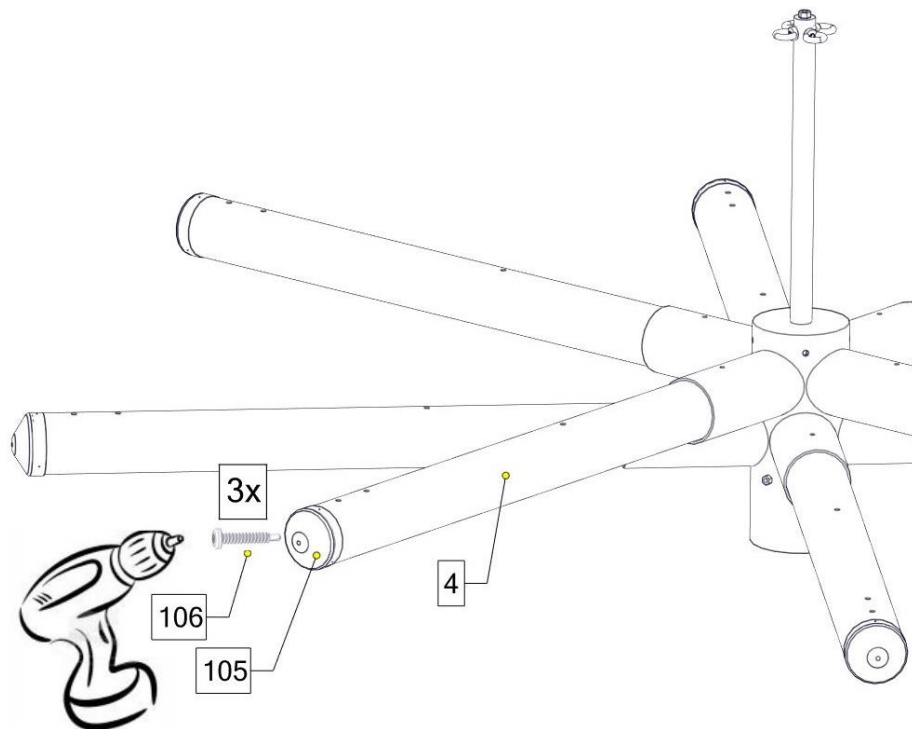
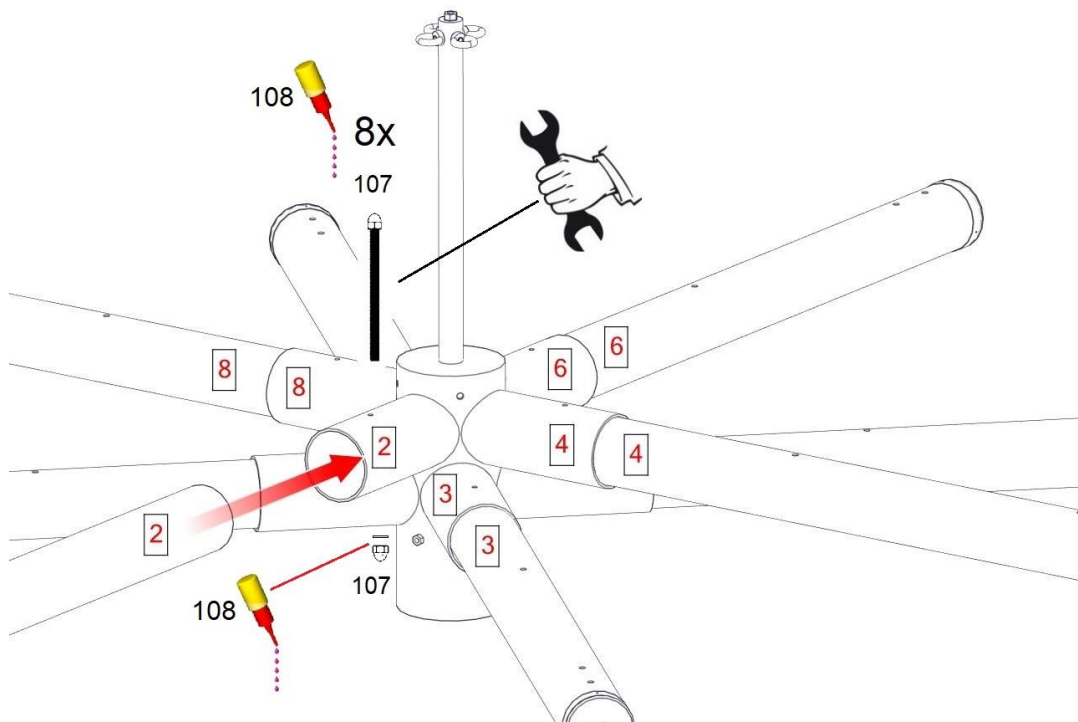

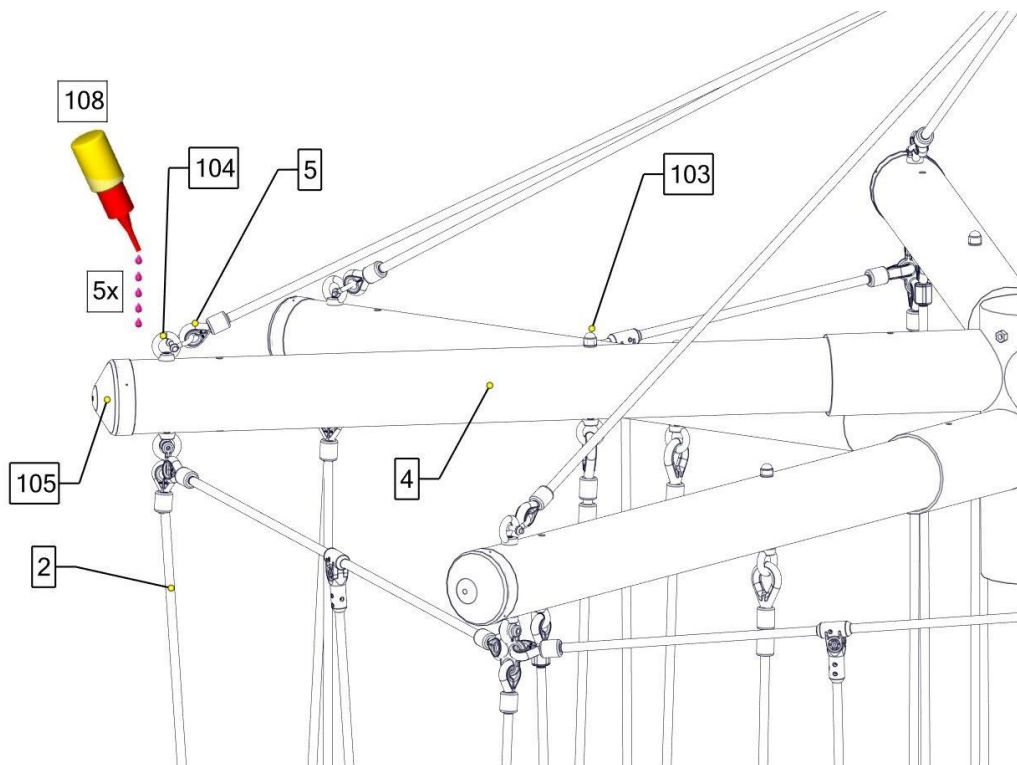
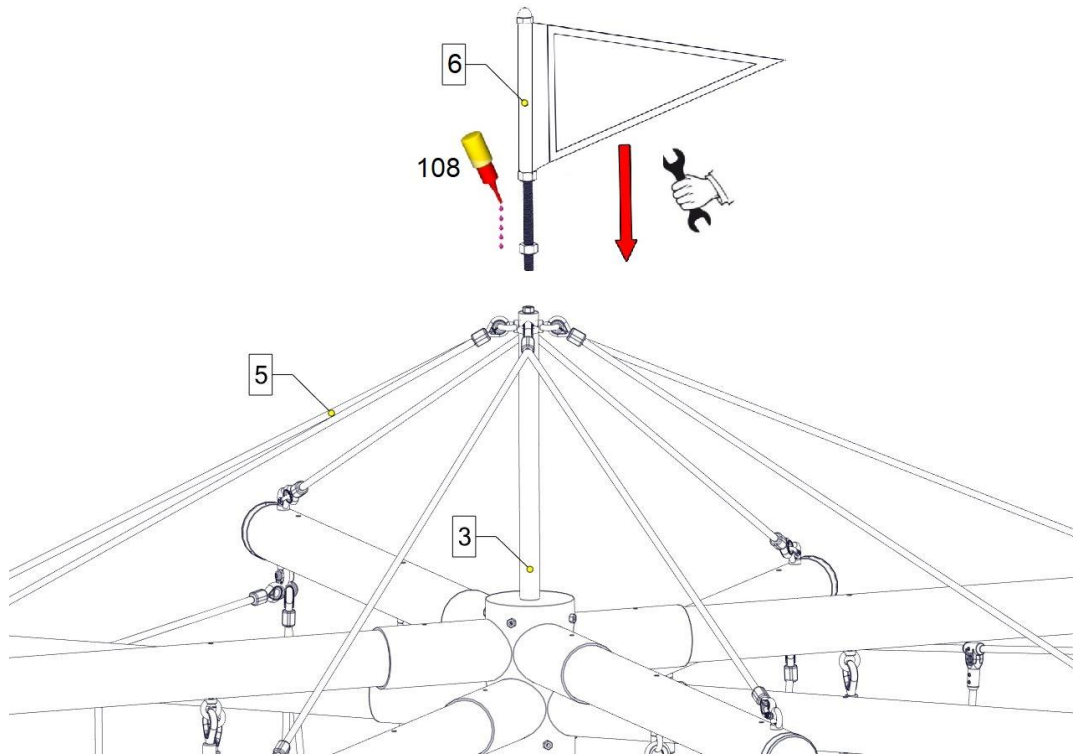

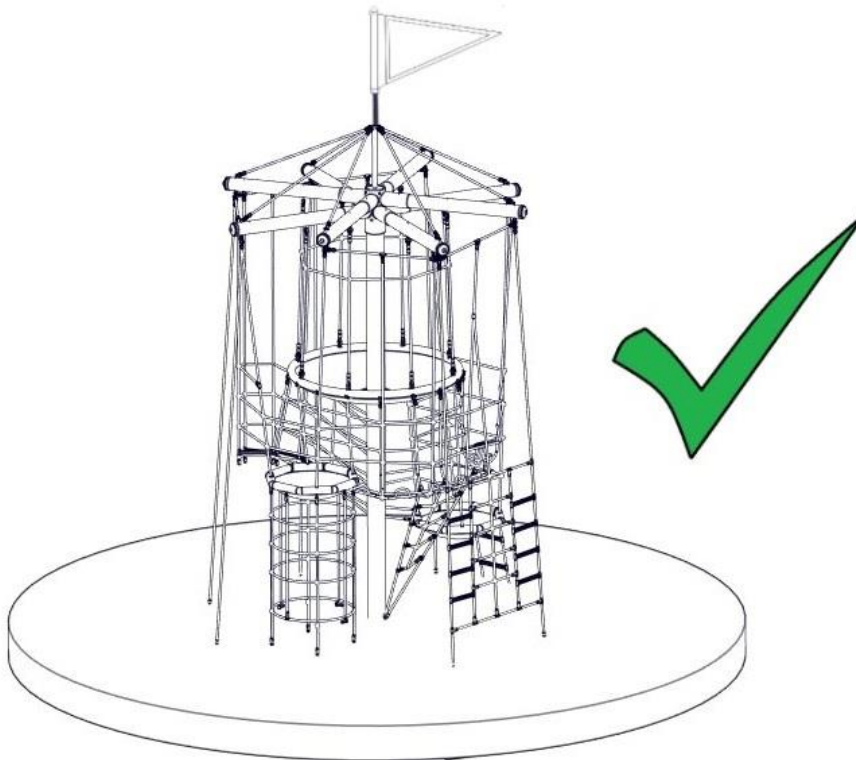
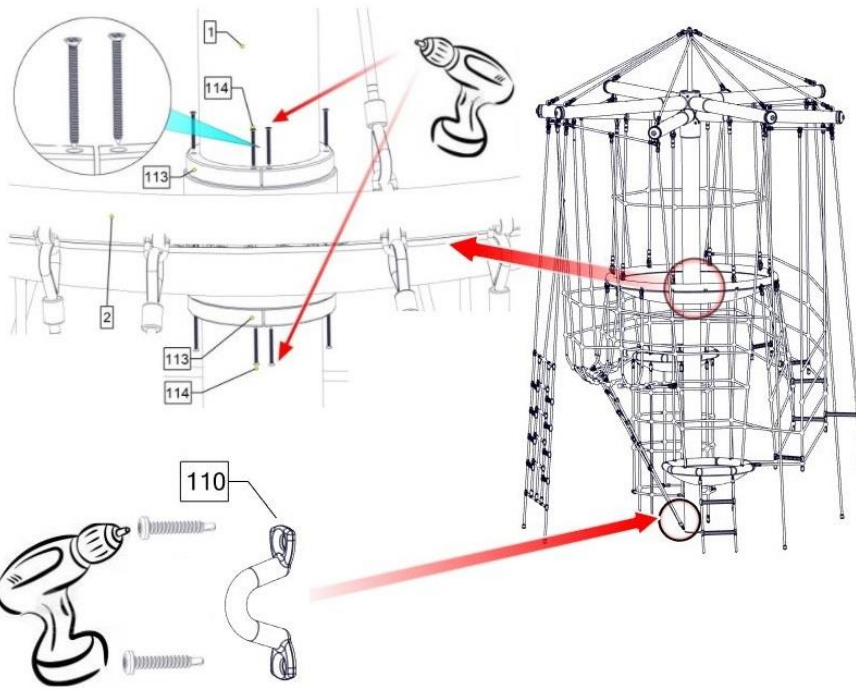

5 Post installation checks



Make sure that the public are kept away from the equipment until it is properly installed.

5.1 Marking filler depth

- Labelling the posts to show the depth of material provided as fall protection (i.e. loose filler).

5.2 The equipment has not been installed safely in the following cases:

- Installation of equipment is not complete.
- The protective surface has not been installed yet.
- Appropriate maintenance work cannot guarantee operational safety.

5.3 Removal of all assembly aids

- Please make sure that all assembly aids have been removed from the playing area. The equipment must not be approved for use until this check has been carried out.

5.4 Information about inspection of the equipment before it is used for the first time

- There are no special inspection requirements to be met before the equipment is used for the first time.

5.5 Retighten bolts

- After one week of play, please retighten all bolts again. Later upon respective maintenance.

B Maintenance Instructions **Eagle´s nest tree, Art.-Nr. 4652-40**

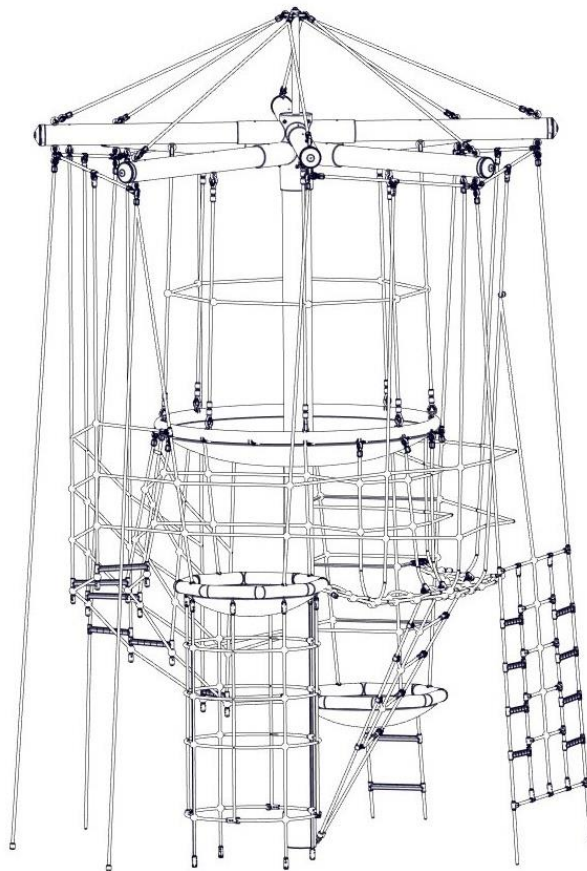

Revisionshistorie

Revision 0 – 2013-10-17

Erste freigegebene Version

Wartungsanleitung SF

Revision 6 – 2022-02-08

Neue Form der Anleitung FH

Alle Rechte vorbehalten

© Copyright 2013 Huck Seiltechnik GmbH

6 Introduction Maintenance

6.1 General informations

This equipment should be installed, inspected, maintained and operated in accordance with EN 1176-7 guidelines.



Please note: Providing any necessary repairs are carried out, a piece of play equipment that is inspected regularly cannot become so damaged that it is dangerous.

Any spare parts which may be required can be obtained directly from your supplier.



This equipment should only be assembled, maintained and repaired by **persons with the necessary expertise.**

A copy of the inspection record should be given to the operator, who must confirm receipt.

**This maintenance instruction is based on the standard
“EN 1176-1:2017”.**

7 General maintenance information

7.1 Maintenance intervals

Maintenance intervals are based on average use. Please note that more frequent inspections and/or maintenance are required if the play equipment is subject to intensive use.

7.2 Inspection frequency

The frequency of inspections must be based on actual use. Factors that affect frequency include vandalism, location (e.g. coastal proximity), air pollution and the age of the equipment.

7.3 Maintenance products and procedures

All nuts and bolts are hot-dip galvanised or stainless steel. One of the characteristics of stainless steel is that uncontrolled cold welding may occur when the nuts are tightened. To prevent this, it is necessary to spray the nuts and bolts with Teflon spray or another similar lubricant.

7.4 Spare parts

All spare parts must conform to the manufacturer's specifications.

7.5 Identifying spare parts

All spare parts are listed in the parts list. The parts list follows the installation requirements.

7.6 Special instructions for the disposal of individual equipment components

No special instructions are necessary.

7.7 Special measures during the break-in period

No later than 2 weeks after assembly, all screwed connections should be checked and tightened if necessary.

7.8 Maintenance of protective surfaces

Surfaces providing fall protection must also be maintained regularly. It is particularly important to maintain the correct level of loose surface material and add more if necessary.

7.9 Faults



Damages must be repaired as soon as they are detected. If serious defects that affect the safety cannot be repaired straight away, the playground item must be blocked with immediate effect.

7.10 Loose screws



Loose screws always cause quality problems and put safety at risk. Therefore, loose screws should always be tightened and checks carried out to ensure that there are no missing screws.

7.11 Preventing equipment use

Use of the equipment should be prevented in the event of incomplete installation, disassembly, maintenance, repairs and faults.

7.12 Claims/liability for faults (steel poles)

Steel posts and footings are covered by our guarantee if regular maintenance is carried out and recorded in writing.

Our general terms and conditions apply. Maintenance of steel poles first takes place after 3 years. The steel posts must be excavated down to the concrete foundations and checked for corrosion.

Zinc paint should be applied to any corroded areas and scratches.

Check ropes for abrasion, replace ropes where coating is damaged down the Steel inlet.

8 Maintenance timetable

8.1 Special advices

8.1.1 Maintenance interval

We strongly advise you to carry out inspections and maintenance work within the specified periods as use of the equipment, the weather and malicious vandalism cause wear and tear that compromises the safety and function of the equipment.

8.1.2 Maintenance intervals in the event of intensive use

Please note that more frequent inspections and/or maintenance are required if the play equipment is subject to intensive use.

8.1.3 Faults that compromise safety



In the event of a fault that compromises safety, quick action must be taken. This may involve repairing it immediately or shutting down and dismantling the equipment.

8.1.4 Faults that compromise function



Faults that compromise function should also be repaired immediately. Such faults lower the value of the equipment to the user and encourage malicious vandalism, which may render the equipment less safe. Any damage should also be repaired immediately.

9 Regular maintenance

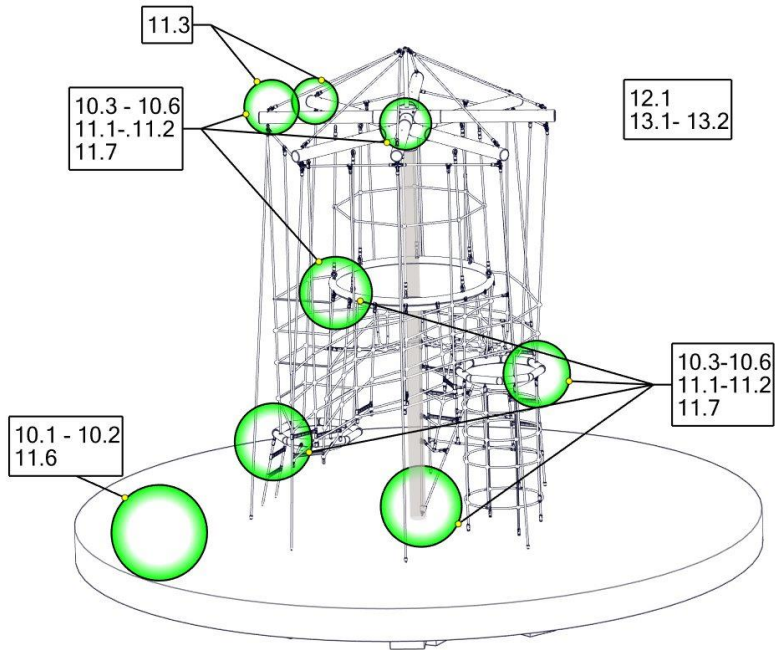

10 Monthly maintenance

- 10.1 Check the spaces between the equipment and the ground (clearance and height of fall).**
- 10.2 Check the ground surface of fall protection for hard objects and loose foundations.**
- 10.3 Check all connecting elements and fittings for wear and tear and tighten if necessary. Replace damaged or missing parts.**
- 10.4 Check that moving metal parts (joints, springs, etc.) move smoothly and are not worn. Replace if necessary. It is not necessary to lubricate joints as we only use maintenance-free metal roller bearings.**
- 10.5 Check all attachments such as chains, ropes, nets, etc. for damage and replace if necessary.**
- 10.6 Check rubber parts, sleeves, etc. for wear and tear or damage and replace if necessary.**
- 10.7 If necessary, remove excess padding material from the post footings due to danger of rotting.**
- 10.8 Check the surface of wooden parts for damage caused by the weather or external influences and mould. Repair or replace if necessary.**
- 10.9 Check the surface of plastic and metal parts, e.g. slides, for damage and replace if necessary.**

11 Quarterly maintenance

- 11.1 Detailed inspection of the operation and stability of the equipment paying particular attention to any wear and tear.**
- 11.2 Tighten all forms of attachment.**
- 11.3 Repaint and retreat surfaces.**
- 11.4 Maintenance of fall protection surfaces.**
- 11.5 Lubrication of joints.**
- 11.6 Check height of fall protection material and top up with loose filler if necessary. If the posts are labelled, top up to the mark.**
- 11.7 Retighten all bolts.**
- 11.8 Tighten the turnbuckles of the netting in three steps (crosswise) and always keep the center pole in line.**

To accelerate the strain of the ropes, 1 person has to climb and jump on-to the 8 tension ropes after each step of tightening.

The preliminary end tension of the pyramid is reached when the tension ropes in shoulder height will not move more than 5cm (press by thumb).

After complete tightening, lock the nuts of the turnbuckles.

12 Half yearly maintenance

- 12.1 The stability of supporting posts, supports, foundations etc. has to be checked. The safety level of the entire system has to be checked after repairs have been carried out or additional system components have been installed or replaced.



Annual Maintenance

13 Annual maintenance

- 13.1 Ascertaining that the equipment, foundations and surfaces are safe for operation.
- 13.2 In particular, the equipment should be checked for decay and corrosion. It may be necessary to dig out or excavate certain components in order to do so. Zinc paint should be applied to corroded areas and scratches.



The equipment must be inspected by someone **with the necessary expertise** in strict compliance with the instructions issued by Huck Seiltechnik GmbH.

A copy of the inspection record should be given to the operator, who must confirm receipt.

14 Maintenance printout

Name of item: Eagle´s nest tree _____ / Art.-Nr. 4652-40 _____

Location: _____

Customer or operator: _____
(Town, Town council, Kindergarten)

Date of inspection	Inspector	O.K.	Accessible	Barriered	Defects	Repaired by	Date

**Please copy and return once a year after main inspection has been carried out to the manufacturer by Telefax +49(0)6443/ 83 11 79!
Place the confirmation form in the play equipment files.**

15 Hand over document



After the installation of the equipment pass the installation and maintenance documents to the operator. The operator has to receive the hand over documents. The complete filled and signed hand over document should be sent to the supplier.

Art.-No.: 4652-40

Type of item: Eagle´s nest tree

Serial number: _____

Customer or operator (Town, Town council, Kindergarten, etc.):

Competent person in charge:

Installation company (address):

Responsible assistant (assembler):

Received the complete assembly instructions, maintenance instructions and maintenance printout.

(Signature of operator) (Signature of installation company)
(Stamp)

Date: _____