











# Polyester Hammock

Art. No. 807-200



For symbol explanation see folding card at the back

-  Lying area: 0.65 x 1.50 m
-  1.44 m
-  3.15 x 0.65 m
-  14.20 m<sup>2</sup>
-  4.40 x 3.65 m
-  0.65 m
-  2
- 

Technical data is based on specific example and changes according to installation height

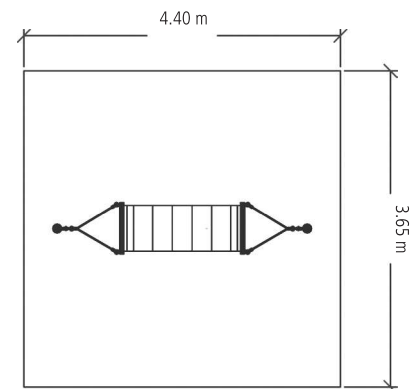

Steel posts for polyester Hammocks incl. Suspension bearings  
Art. No. 805-200

